

3-2 The installation of lighting and light-signaling devices: Effective date from 2011/1/1

Refer to: R48 04-S1/C1, R53 01-S9, R74 01-S2/C1, R104 00-S2

3-2.1 Effective date and Scope:

- 3-2.1.1 Effective date from 2011/1/1, the new vehicle variants of category symbols M, N and O, shall comply with paragraphs 3-2.4, 3-2.6 to 3-2.8 specified in this regulation
- 3-2.1.2 Effective date from 2013/1/1, all vehicle variants of category symbols M, N and O, which were confirmed to "3-1 The installation of lighting and light-signaling devices" of "Directions", if its lighting and signal-lighting devices equip with adaptive front lighting system (AFS) and /or emergency braking signal, it shall comply with related stipulation of adaptive front lighting system (AFS) and/or emergency braking signal of this regulation in addition.
- 3-2.1.3 Effective date from 2011/1/1, the new vehicle variants of category symbols L1 and L3, and all vehicle variants of category symbols L2 and L5, shall comply with paragraphs 3-2.5 to 3-2.8 specified in this regulation.
- 3-2.1.4 The same applicant applying for low volume safety approval and the vehicle amount is not over 20 at same year and with same type and specification; or the same applicant applying for vehicle-by-vehicle low volume safety approval and the vehicle amount is not over 20 at same year and with same type and specification, could exempt from the requirement of Horizontal orientation in 3-2.4.2.5.2 and/or adaptive front lighting system (AFS) in 3-2.6.16.
- 3-2.1.5 As for the vehicle category O3 and O4 from 2010/7/1, the dimensions and marking shape and mounting requirements of its body's side and rear retro-reflective marking with strips shall comply with paragraph 3-2.6.14.2 and 3-2.6.14.3.1 specified below in this regulation, and the retro-reflective markings used shall comply with the requirements for "retro-reflective markings" in these Directions.

3-2.2 Definitions:

- 3-2.2.1 "Lamp" means a device designed to illuminate the road or to emit a light signal to other road users. Rear registration plate lamps and retro-reflectors are likewise to be regarded as lamps. For the purpose of this Regulation, light-emitting rear registration plates and the service-door-lighting system are not considered as lamps.
  - 3-2.2.1.1 "A single lamp" means:
    - 3-2.2.1.1.1 a device or part of a device having one lighting or light-signalling function, one or more light source(s) and one apparent surface in the direction of the reference axis, which may be a continuous surface or composed of two or more distinct parts, or
    - 3-2.2.1.1.2 any assembly of two independent lamps, whether identical or not, having the same function, both approved as type "D" lamp and installed so that the projection of their apparent surfaces in the direction of the reference axis occupies not less than 60 percent of the smallest quadrilateral circumscribing the projections of the said apparent surfaces in the direction of the reference axis.
- 3-2.2.2 Light emitting surface: means all or part of the exterior surface of the transparent material, Fig 1.
- 3-2.2.3 Illuminating surface: means the orthogonal projection of the full aperture of the reflector with an ellipsoidal reflector of the "projection lens" on a transverse plane, Fig 1. For illuminating surface of adaptive front lighting system: where a lighting function is produced by two or more simultaneously operated lighting units on a given side of the vehicle, the individual illuminating surfaces are taken together to constitute the illuminating surface

The official directions are written in Chinese, this English edition is for your reference only.

The non-inclined line area  
is the essential test area B  
Test area A

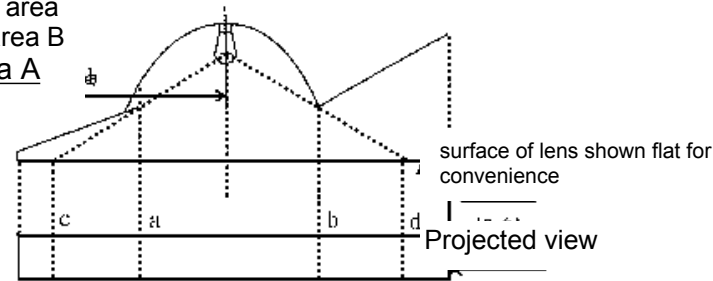

a & b : illuminating surface  
c & d : Light-emitting surface

FIG 1

- 3-2.2.4 Bend lighting: means a lighting function to provide enhanced illumination in bends.
- 3-2.2.5 Apparent surface: means the orthogonal projection of: either the boundary of the illuminating surface projected on the exterior surface of the lens, or the light-emitting surface, in a plane perpendicular to the direction of observation and tangential to the most exterior point of the lens. For light-signalling device producing variable luminous intensities, its variable apparent surface under all possible conditions of the variable intensity control shall be considered.
- 3-2.2.6 Height above the ground: The maximum height above the ground shall be measured from the highest point and the minimum height from the lowest point of the apparent surface in the direction of the reference axis.
- 3-2.2.7 Tell-tale: means a visual signal (or any equivalent signal) indicating that a device has been switched on and is operating correctly. An auditory signal can be used as alternative if stipulated in specific Regulations.
- 3-2.2.8 Angles of geometric visibility: the angles which determine the field of the minimum solid angle in which the apparent surface of the lamp must be visible. If, when the lamp is installed, any part of the apparent surface of the lamp is hidden by any further parts of the vehicle, proof shall be furnished that the part of the lamp not hidden by obstacles still conforms to the photometric values prescribed for the approval of the device as an optical unit.
- 3-2.2.9 Device: means an element or an assembly of elements used to perform one or more functions.
- 3-2.2.9.1 Lighting function: means the light emitted by a device to illuminate the road and objects in the direction of vehicle movement.
- 3-2.2.9.2 Light-signalling function: means the light emitted or reflected by a device to give to other road users visual information on the presence, identification and/or the change of movement of the vehicle.
- 3-2.2.10 Non-replaceable light source: means a light source which can only be replaced by replacement of the device to which this light source is fixed;
- in case of a light source module: a light source which can only be replaced by replacement of the light source module to which this light source is fixed;
  - in case of adaptive front-lighting systems (AFS): a light source which can only be replaced by replacement of the lighting unit to which this light source is fixed;"
- 3-2.2.11 "Light-emitting diode (LED) light source" means a light source where the element for visible radiation is one or more solid state junctions producing injection-luminescence/ fluorescence;

The official directions are written in Chinese, this English edition is for your reference only.

- 3-2.2.12 "LED module" means a light source module containing as light sources only LEDs.
- 3-2.2.13 "Principal passing beam (principal dipped beam)" means the dipped beam produced without the contribution of infrared (IR) emitter and/or additional light sources for bend lighting.
- 3-2.2.14 Variable intensity control: means the device which automatically controls rear light signaling devices producing variable luminous intensities to assure the unvarying perception of their signals. The variable intensity control is part of the lamp, or part of the vehicle, or split between the said lamp and the vehicle.
- 3-2.2.15 Adaptive front lighting system (or "AFS"): means a lighting device type-approved according to Regulation No. 59, providing beams with differing characteristics for automatic adaptation to varying conditions of use of the dipped-beam (passing beam) and, if it applies, and the main-beam (driving-beam);
- 3-2.2.15.1 Lighting unit: means a light-emitting component designed to provide or contribute to one or more front lighting function(s) provided by the AFS;
- 3-2.2.15.2 Installation unit: means an indivisible housing (lamp body) which contains one or more lighting unit(s);
- 3-2.2.15.3 Lighting mode or mode: means a state of a front lighting function provided by the AFS, as specified by the manufacturer and intended for adaptation to specific vehicle and ambient conditions;
- 3-2.2.15.4 System control: means that part(s) of the AFS receiving the AFS control signals from the vehicle and controlling the operation of the lighting units automatically;
- 3-2.2.15.5 AFS control signal (V, E, W, T): means the input to the AFS in accordance with the paragraph 3-2.6.16.7.4 of this Regulation;
- 3-2.2.15.6 Neutral state: means the state of the AFS when a defined mode of the class C passing beam ("basic passing beam") or of the main beam, if any, is produced, and no AFS control signal applies.
- 3-2.2.16 The verification of lamp position and lighting direction : In the absence of specific instructions, the height and orientation of the lamps shall be verified with the vehicle unladen and placed on a flat, horizontal surface in the condition defined in paragraphs 3-2.2.15.8, 3-2.2.15.8.1 and 3-2.3.15.8.2. If AFS is also fitted, then the system shall be in normal situation.
- 3-2.2.17 Normal position of use of a movable component: means the position(s) of a movable component specified by the vehicle manufacturer for the normal condition of use and the park condition of the vehicle.
- 3-2.2.18 Normal condition of use of a vehicle means:
- 3-2.2.18.1 for a motor vehicle, when the vehicle is ready to move with its propulsion engine running and its movable components in the normal position(s) as defined in paragraph 3-2.2.17
- 3-2.2.18.2 and for a trailer, when the trailer is connected to a drawing motor vehicle in the conditions as prescribed in paragraph 3-2.2.18.1 and its movable components are in the normal position(s) as defined in paragraph 3-2.2.17.
- 3-2.2.19 Emergency stop signal: means a signal to indicate to other road users to the rear of the vehicle that a high retardation force has been applied to the vehicle relative to the prevailing road conditions.
- 3-2.2.20 Colour of the light emitted from a device
- 3-2.2.20.1 "White" means the chromaticity coordinates (x,y) of the light emitted that lie inside the chromaticity areas defined by the boundaries:
- W12 green boundary:  $y = 0.150 + 0.640 x$
- W23 yellowish green boundary:  $y = 0.440$
- W34 yellow boundary:  $x = 0.500$

The official directions are written in Chinese, this English edition is for your reference only.

W45 reddish purple boundary:  $y = 0.382$   
 W56 purple boundary:  $y = 0.050 + 0.750 x$   
 W61 blue boundary:  $x = 0.310$   
 with intersection points:

|                  | x     | y     |
|------------------|-------|-------|
| W <sub>1</sub> : | 0.310 | 0.348 |
| W <sub>2</sub> : | 0.453 | 0.440 |
| W <sub>3</sub> : | 0.500 | 0.440 |
| W <sub>4</sub> : | 0.500 | 0.382 |
| W <sub>5</sub> : | 0.443 | 0.382 |
| W <sub>6</sub> : | 0.310 | 0.283 |

3-2.2.20.2 "Selective-yellow" means the chromaticity coordinates (x,y) of the light emitted that lie inside the chromaticity areas defined by the boundaries:

SY12 green boundary:  $y = 1.290 x - 0.100$   
 SY23 the spectral locus  
 SY34 red boundary:  $y = 0.138 + 0.580 x$   
 SY45 yellowish white boundary:  $y = 0.440$   
 SY51 white boundary:  $y = 0.940 - x$   
 with intersection points:

|                   | x     | y     |
|-------------------|-------|-------|
| SY <sub>1</sub> : | 0.454 | 0.486 |
| SY <sub>2</sub> : | 0.480 | 0.519 |
| SY <sub>3</sub> : | 0.545 | 0.454 |
| SY <sub>4</sub> : | 0.521 | 0.440 |
| SY <sub>5</sub> : | 0.500 | 0.440 |

3-2.2.20.3 "Amber" means the chromaticity coordinates (x,y) of the light emitted that lie inside the chromaticity areas defined by the boundaries:

A12 green boundary:  $y = x - 0.120$   
 A23 the spectral locus  
 A34 red boundary:  $y = 0.390$   
 A41 white boundary:  $y = 0.790 - 0.670 x$   
 with intersection points:

|  | x | y |
|--|---|---|
|--|---|---|

The official directions are written in Chinese, this English edition is for your reference only.

|                  |       |       |
|------------------|-------|-------|
| A <sub>1</sub> : | 0.545 | 0.425 |
| A <sub>2</sub> : | 0.557 | 0.442 |
| A <sub>3</sub> : | 0.609 | 0.390 |
| A <sub>4</sub> : | 0.597 | 0.390 |

3-2.2.20.4 "Red" means the chromaticity coordinates (x,y) of the light emitted that lie inside the chromaticity areas defined by the boundaries:

R12 yellow boundary:  $y = 0.335$

R23 the spectral locus

R34 the purple line (its linear extension across the purple range of colours between the red and the blue extremities of the spectral locus).

R41 purple boundary:  $y = 0.980 - x$

with intersection points:

|                  | x     | y     |
|------------------|-------|-------|
| R <sub>1</sub> : | 0.645 | 0.335 |
| R <sub>2</sub> : | 0.665 | 0.335 |
| R <sub>3</sub> : | 0.735 | 0.265 |
| R <sub>4</sub> : | 0.721 | 0.259 |

3-2.2.21 "Manoeuvring lamp" means a lamp used to provide supplementary illumination to the side of the vehicle to assist during slow manoeuvres.

3-2.3 The principles for regarding applicable variants and scope of the installation of lighting and light-signaling devices are as below :

3-2.3.1 The same vehicle category symbol.

3-2.3.2 The same variant of vehicle body.

3-2.3.3 The same axle set variant.

3-2.3.4 The same brand and vehicle type.

3-2.3.5 The chassis vehicle have had same axle set variant.

3-2.3.6 The same chassis brand.

3-2.3.7 Chassis manufacturers announced that the same chassis vehicle type .

3-2.3.8 If use chassis vehicle instead of completed vehicle for entire or partial testing, which shall according to suitable variants and range of principle are as below :

3-2.3.8.1 The chassis vehicle have had same axle set variant.

3-2.3.8.2 The same brand.

3-2.3.8.3 Chassis manufacturers announced that the same chassis vehicle type.

3-2.4 In the case of motor vehicles and trailers

3-2.4.1 Main-beam headlamp: Prohibited on trailers. Where an AFS is fitted and if it provides main-beam function(s), it shall be considered

- equivalent to a pair of main-beam headlamps.
- 3-2.4.1.1 The main-beam headlamp shall conform to requirements concerning “Headlamps” or “Gas-discharge Headlamps” regulated in VSTD.
  - 3-2.4.1.2 Number: Two or four installed symmetrically on vehicle’s both sides. Where a vehicle is fitted with four concealable headlamps the installation of two additional headlamps shall only be authorized for the purpose of light-signalling, consisting of intermittent illumination, at short intervals in daylight.
  - 3-2.4.1.3 The colour of the light emitted by the lamps: white and for both the two side lamps it shall be identical.
  - 3-2.4.1.4 In length: at the front of the vehicle and fitted in such a way that the light emitted does not cause discomfort to the driver either directly or indirectly through the rear-view mirrors and/or other reflecting surfaces of the vehicle.
  - 3-2.4.1.5 Geometric visibility: The visibility of the illuminating surface, including its visibility in areas which do not appear to be illuminated in the direction of observation considered, must be ensured within a divergent space defined by generating lines based on the perimeter of the illuminating surface and forming an angle of not less than 5 degrees with the axis of reference of the headlamp.
  - 3-2.4.1.6 Orientation: Towards the front. Not more than one main-beam headlamp on each side of the vehicle may swivel to produce bend lighting.
  - 3-2.4.1.7 Electrical connections: The main-beam headlamps may be switched on either simultaneously or in pairs. For changing over from the dipped to the main beam at least one pair of main-beam headlamps shall be switched on. For changing over from the main-beam to the dipped-beam all main-beam headlamps shall be switched off simultaneously. The dipped-beams may remain switched on at the same time as the main beams.
  - 3-2.4.1.8 Tell-tale: Circuit-closed tell-tale mandatory.
  - 3-2.4.1.9 Other requirements:
    - 3-2.4.1.9.1 The aggregate maximum intensity of the lighting units that can be energized simultaneously to provide the main-beam lighting or its modes, if any, shall not exceed 225000 cd.
    - 3-2.4.1.9.2 The main-beam headlamps may substitute the function of the front position lamps, provided that:
      - 3-2.4.1.9.2.1 Their electrical connections are such that in case of failure of any of these lighting devices the front position lamps are automatically re-activated; and
      - 3-2.4.1.9.2.2 The substituting lamp/function meets, for the respective position lamp, the requirements concerning:
        - (1) The geometric visibility prescribed for the front position lamps in 3-2.4.3.4; and
        - (2) The minimum photometric values according to the angles of light distribution; and
      - 3-2.4.1.9.2.3 Appropriate evidence demonstrating compliance with the requirements indicated in paragraph 3-2.4.1.9.2.2. above is provided in the test reports of the substituting lamp.
- 3-2.4.2 Dipped-beam headlamp: Prohibited on trailers. Where an AFS is fitted, it shall be considered equivalent to a pair of dipped-beam headlamps.
  - 3-2.4.2.1 Number: Two. And the dipped-beam headlamp shall conform to requirements concerning “Headlamps” or “Gas-discharge Headlamps” regulated in VSTD.
  - 3-2.4.2.2 The colour of the light emitted by the lamps: white and for both the two side lamps it shall be identical.
  - 3-2.4.2.3 Position:

The official directions are written in Chinese, this English edition is for your reference only.

- 3-2.4.2.3.1 In width: that edge of the apparent surface in the direction of the reference axis which is farthest from the vehicle's median longitudinal plane shall be not more than 400 mm from the extreme outer edge of the vehicle. The inner edges of the apparent surfaces in the direction of the reference axes shall be not less than 600 mm apart. This does not apply, however, for M1 and N1 category vehicles; for all other categories of motor vehicles this distance may be reduced to 400 mm where the overall width of the vehicle is less than 1,300 mm.
- 3-2.4.2.3.2 In height: not less than 500 mm and not more than 1,200 mm above the ground. For category N3G (off-road) vehicles, the maximum height may be increased to 1,500 mm.
- 3-2.4.2.3.3 In length: at the front of the vehicle. This requirement shall be deemed to be satisfied if the light emitted does not cause discomfort to the driver either directly, or indirectly through the rear-view mirrors and/or other reflecting surfaces of the vehicle.
- 3-2.4.2.4 Geometric visibility:
- 3-2.4.2.4.1 15 degrees upwards and 10 degrees downwards, 45 degrees outwards and 10 degrees inwards.
- 3-2.4.2.4.2 Since the photometric values required for dipped-beam headlamps do not cover the full geometric field of vision, a minimum value of 1 cd in the space remaining is required for type-approval purposes. The presence of partitions or other items of equipment near the headlamp shall not give rise to secondary effects causing discomfort to other road users.
- 3-2.4.2.5 Orientation: Towards the front.
- 3-2.4.2.5.1 Vertical orientation:
- 3-2.4.2.5.1.1 The initial downward inclination of the cut-off of the dipped-beam to be set in the unladen vehicle state with one person in the driver's seat shall be specified within an accuracy of 0.1 per cent by the manufacturer and indicated in a clearly legible and indelible manner on each vehicle close to either headlamp or the manufacturer's plate by the symbol.
- 3-2.4.2.5.1.2 Depending on the mounting height in metres (h) of the lower edge of the apparent surface in the direction of the reference axis of the dipped-beam headlamp, measured on the unladen vehicles, the vertical inclination of the cut-off of the dipped-beam shall, under all the static conditions, remain between the following limits and the initial aiming shall have the following values:
- 3-2.4.2.5.1.2.1  $h < 0.8$ :
- limits : between -0.5 % and -2.5 %  
initial aiming: between -1.0 % and -1.5 %
- 3-2.4.2.5.1.2.2  $0.8 \leq h \leq 1.0$ :
- limits : between -0.5 % and -2.5 %  
initial aiming: between -1.0 % and -1.5 %  
or, at the discretion of the manufacturer,  
limits : between -1.0 % and -3.0 %  
initial aiming: between -1.5 % and -2.0 %
- 3-2.4.2.5.1.2.3  $h > 1.0$ :
- limits : between -1.0 % and -3.0 %  
initial aiming: between -1.5 % and -2.0 %

The official directions are written in Chinese, this English edition is for your reference only.



3-2.4.2.5.1.2.4 The above limits and the initial aiming values are summarized in the diagram Fig 2 below:

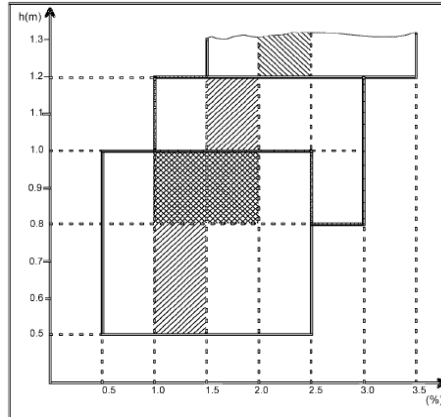

Fig 2

3-2.4.2.5.1.2.5 For category N3G (off-road) vehicles where the headlamps exceed a height of 1,200 mm, the limits for the vertical inclination of the cut-off shall be between: -1.5 % and -3.5 %. The initial aim shall be set between: -2 % and -2.5 %.

3-2.4.2.5.2 Horizontal orientation: The horizontal orientation of one or both dipped-beam headlamps may be varied to produce bend lighting, provided that if the whole beam or the kink of the elbow of the cut-off is moved, the kink of the elbow of the cut-off shall not intersect the line of the trajectory of the centre of gravity of the vehicle at distances from the front of the vehicle which are larger than 100 times the mounting height of the respective dipped-beam headlamps.

3-2.4.2.6 Electrical connections:

3-2.4.2.6.1 The control for changing over to the dipped-beam must switch off all main-beam headlamps simultaneously.

3-2.4.2.6.2 The dipped beam may remain switched on at the same time as the main beams. In the case of dipped-beam headlamps of the gasdischarge light sources, it shall remain switched on during the main beam operation.

3-2.4.2.6.3 One additional light source or one or more LED module(s), located inside the dipped-beam headlamps or in a lamp (except the main-beam headlamp) grouped or reciprocally incorporated with the respective dipped-beam headlamps, may be activated to produce bend lighting, provided that the horizontal radius of curvature of the trajectory of the centre of gravity of the vehicle is 500 m or less.

3-2.4.2.6.4 Dipped-beam headlamps may be switched ON or OFF automatically. However, it shall be always possible to switch these dipped-beam headlamps ON and OFF manually.

3-2.4.2.7 Other requirements:

3-2.4.2.7.1 Headlamp levelling device

3-2.4.2.7.1.1 In the case where a headlamp levelling device is necessary to satisfy the requirements of paragraphs 3-2.4.2.5.1. the device shall be automatic.

3-2.4.2.7.1.2 If comply with following paragraph that paragraph 3-2.4.2.7.1.1 shall be manually, devices which are adjusted



manually, either continuously or non-continuously, shall be permitted, provided they have a stop position at which the lamps can be returned to the initial inclination defined in paragraph 3-2.4.2.5.1.1 by means of the usual adjusting screws or similar means. These manually adjustable devices must be operable from the driver's seat.

3-2.4.2.7.1.3 In the event of a failure of devices, the dipped-beam shall not assume a position in which the dip is less than it was at the time when the failure of the device occurred.

3-2.4.2.7.2 Be symmetrical to one another in relation to the median longitudinal plane, this requirement is not valid with regard to the interior structure of the lamp;

3-2.4.2.7.3 With respect to vertical inclination the provisions of paragraph 3-2.4.2.7.1.2 above shall not be applied for dipped-beam headlamps. In the case where a headlamp levelling device shall be automatic:

(a) With LED module(s) producing the principal dipped beam, or

(b) With a light source producing the principal dipped beam and having an objective luminous flux which exceeds 2,000 lumen.

3-2.4.2.7.4 Only the dipped-beam headlamp that conforms to the gas-discharging type headlamp or asymmetric headlamp may be used to produce bend lighting. And it should have the function to adjust to the normal using position for fail-safe.

3-2.4.2.7.5 If bend lighting is produced by a horizontal movement of the whole beam or the kink of the elbow of the cut-off, it shall be activated only if the vehicle is in forward motion; this shall not apply if bend lighting is produced for a right turn.

3-2.4.2.7.6 The dipped-beam headlamps may substitute the function of the front position lamps, provided that:

3-2.4.2.7.6.1 Their electrical connections are such that in case of failure of any of these lighting devices the front position lamps are automatically re-activated; and

3-2.4.2.7.6.2 The substituting lamp/function meets, for the respective position lamp, the requirements concerning:

(1) The geometric visibility prescribed for the front position lamps in 3-2.4.3.4; and

(2) The minimum photometric values according to the angles of light distribution; and

3-2.4.2.7.6.3 Appropriate evidence demonstrating compliance with the requirements indicated in paragraph 3-2.4.2.7.6.2. above is provided in the test reports of the substituting lamp.

#### 3-2.4.2.8 Tell-tale

3-2.4.2.8.1 Tell-tale optional

3-2.4.2.8.2 A visual tell-tale whether flashing or not is mandatory:

(a) in the case where the whole beam or the kink of the elbow of the cut-off is moved to produce bend lighting, or

(b) if one or more LED modules are used to produce the principal dipped-beam.

It shall be activated:

(a) in the event of a malfunction of the displacement of the kink of the elbow of the cut-off, or

(b) in case of a failure of any one of the LED module(s) producing the principal dipped-beam.

It shall remain activated while the failure is present. It may be cancelled temporarily, but shall be repeated whenever the device, which starts and stops the engine, is switched on and off.

3-2.4.3 Front position lamp: Optional on trailers which are not more than 1,600 mm wide.

3-2.4.3.1 Number: Two. And the front position lamp shall conform to requirements concerning "Front position lamps" regulated in VSTD.

3-2.4.3.2 The colour of the light emitted by the lamps: white.

3-2.4.3.3 Position:

3-2.4.3.3.1 In width: that point on the apparent surface in the direction of the reference axis which is farthest from the vehicle's median longitudinal plane shall not be more than 400 mm from the extreme outer edge of the vehicle. In the case of a trailer, that point on the apparent surface in the direction of the reference axis which is farthest from the median longitudinal plane shall not be more than 150 mm from the extreme outer edge of the vehicle. The distance between the inner edges of the two apparent surfaces in the direction of the reference axes shall: For M1 and N1 category vehicles: have no special requirement; For all other categories of vehicles: be not less than 600 mm. This distance may be reduced to 400 mm where the overall width of the vehicle is less than 1,300 mm.

3-2.4.3.3.2 In height: above the ground, not less than 350 mm nor more than 1,500 mm (2,100 mm for O1 and O2 categories of vehicles, or if for any other categories of vehicles the shape of the bodywork makes it impossible to keep within 1,500 mm).

3-2.4.3.4 Geometric visibility:

3-2.4.3.4.1 Horizontal angle for the two position lamps: 45 degrees inwards and 80 degrees outwards. In the case of trailers, the angle inwards may be reduced to 5 degrees.

3-2.4.3.4.2 Vertical angle: 15 degrees above and below the horizontal. The vertical angle below the horizontal may be reduced to 5 degrees in the case of lamps less than 750 mm above the ground.

3-2.4.3.4.3 For M1 and N1 category vehicles, as an alternative to paragraph 3-2.4.3.4.1 and 3-2.4.3.4.2, at the discretion of the manufacturer or his duly accredited representative, and only if a front side-marker lamp is installed on the vehicle. Horizontal angle: 45 degrees outwards to 45 degrees inwards. Vertical angle: 15 degrees above and below the horizontal. The vertical angle below the horizontal may be reduced to 5 degrees if the lamps are less than 750 mm above the ground. To be considered visible, the lamp must provide an unobstructed view of the apparent surface of at least 12.5 cm<sup>2</sup>. The illuminating surface area of any retro reflector that does not transmit light shall be excluded.

3-2.4.3.5 Orientation: Forwards.

3-2.4.3.6 Electrical connections: The electrical connections must be such that the front and rear position lamps, the end outline marker lamps, if they exist, the side-marker lamps, if they exist, and the rear registration plate lamp can only be switched on and off simultaneously. This condition does not apply when using front and rear position lamps, as well as side-marker lamps when combined or reciprocally incorporated with said lamps, as parking lamps and when side-marker lamps are permitted to flash.

3-2.4.3.7 Tell-tale: Circuit-closed tell-tale mandatory. This tell-tale shall be non-flashing and shall not be required if the instrument panel lighting can only be turned on simultaneously with the front position lamps.

3-2.4.3.8 If one or more infrared radiation generator(s) is (are) installed inside the front position lamp, it (they) is (are) allowed to be activated only when the headlamp on the same side of the vehicle is switched on and the vehicle is in forward motion. In the event that the front position lamp or the headlamp on the same side fails, the infrared radiation generator(s) shall be automatically switched off. In case an AFS providing a bending mode is installed, the front position lamp may be swivelled together with the lighting unit to which it is reciprocally incorporated.

3-2.4.4 Rear position lamp

The official directions are written in Chinese, this English edition is for your reference only.

- 3-2.4.4.1 Number: Two. And the rear position lamp shall conform to requirements concerning “Tail lamps (rear position (side) lamps)” regulated in VSTD.
- 3-2.4.4.2 The colour of the light emitted by the lamps: red.
- 3-2.4.4.3 Position: Except the case where end-outline marker lamps are installed, two optional position lamps may be installed on all vehicles in categories M2, M3, N2, N3, O2, O3, and O4.
  - 3-2.4.4.3.1 In width: that point on the apparent surface in the direction of the reference axis which is farthest from the vehicle's median longitudinal plane shall not be more than 400 mm from the extreme outer edge of the vehicle; this condition shall not apply to the optional rear lamps. The distance between the inner edges of the two apparent surfaces in the direction of the reference axes shall: For M1 and N1 category vehicles: have no special requirement; For all other categories of vehicles: be not less than 600 mm. This distance may be reduced to 400 mm where the overall width of the vehicle is less than 1,300 mm.
  - 3-2.4.4.3.2 In height: above the ground, not less than 350 mm nor more than 1,500 mm (2,100 mm if the shape of the bodywork makes it impossible to keep within 1,500 mm and if the optional lamps are not installed. If the optional lamps are installed, they shall be placed at a height compatible with the applicable requirements of the symmetry of the lamps, and at a vertical distance as large as the shape of the bodywork makes it possible, but not less than 600 mm above the mandatory.
- 3-2.4.4.4 Geometric visibility:
  - 3-2.4.4.4.1 Horizontal angle: 45 degrees inwards and 80 degrees outwards.
  - 3-2.4.4.4.2 Vertical angle: 15 degrees above and below the horizontal. The vertical angle below the horizontal may be reduced to 5 degrees in the case of lamps less than 750 mm above the ground. The vertical angle above the horizontal may be reduced to 5 degrees in the case of optional lamps not less than 2,100 mm above the ground.
  - 3-2.4.4.4.3 For M1 and N1 category vehicles, as an alternative to paragraph 3-2.4.4.4.1 and 3-2.4.4.4.2, at the discretion of the manufacturer or his duly accredited representative, and only if a rear side-marker lamp is installed on the vehicle, Horizontal angle: 45 degrees outwards to 45 degrees inwards. Vertical angle: 15 degrees above and below the horizontal. The vertical angle below the horizontal may be reduced to 5 degrees if the lamps are less than 750 mm above the ground. To be considered visible, the lamp must provide an unobstructed view of the apparent surface of at least 12.5 cm<sup>2</sup>. The illuminating surface area of any retro-reflector that does not transmit light shall be excluded.
- 3-2.4.4.5 Orientation: Rearwards.
- 3-2.4.4.6 Electrical connections: The electrical connections must be such that the front and rear position lamps, the end-outline marker lamps, if they exist, the side-marker lamps, if they exist, and the rear registration plate lamp can only be switched on and off simultaneously. This condition does not apply when using front and rear position lamps, as well as side-marker lamps when combined or reciprocally incorporated with said lamps, as parking lamps and when side-marker lamps are permitted to flash.
- 3-2.4.4.7 Tell-tale: Circuit-closed tell-tale mandatory. It must be combined with that of the front position lamps.
- 3-2.4.5 Rear fog lamp:
  - 3-2.4.5.1 Number: One or two shall conform to requirements concerning “rear fog lamp” regulated in VSTD.
  - 3-2.4.5.2 The colour of the light emitted by the lamps: red.

The official directions are written in Chinese, this English edition is for your reference only.

- 3-2.4.5.3 Position: In length: at the rear of the vehicle.
  - 3-2.4.5.3.1 In width: if there is only one rear fog-lamp, it must be on the opposite side of the median longitudinal plane of the vehicle to the direction of traffic, which is driver's side, the centre of reference may also be situated on the median longitudinal plane of the vehicle.
  - 3-2.4.5.3.2 In height: not less than 250 mm nor more than 1,000 mm above the ground. For category N3G (off-road) vehicles, the maximum height may be increased to 1,200 m
  - 3-2.4.5.3.3 In all cases, the distance between the rear fog-lamp and each stop-lamp must be greater than 100 mm.
- 3-2.4.5.4 Geometric visibility:
  - 3-2.4.5.4.1 The horizontal angle: 25 degrees to right and to left.
  - 3-2.4.5.4.2 The vertical angle: 5 degrees upwards and 5 degrees downwards;
- 3-2.4.5.5 Orientation: Rearwards.
- 3-2.4.5.6 Electrical connections:
  - 3-2.4.5.6.1 These must be such that: The rear fog-lamp(s) cannot be switched on unless the main beams, dipped beams or front fog-lamps are lit;
  - 3-2.4.5.6.2 The rear fog-lamp(s) can be switched off independently of any other lamp;
  - 3-2.4.5.6.3 Either of the following applies:
    - 3-2.4.5.6.3.1 The rear fog lamp(s) may continue to operate until the position lamps are switched off, and the rear fog lamp(s) shall then remain off until deliberately switched on again;
    - 3-2.4.5.6.3.2 A warning, at least audible, additional to the mandatory tell-tale shall be given if the ignition is switched off or the ignition key is withdrawn and the driver's door is opened, whether the lamps in are on or off, whilst the rear fog lamp switch is in the "on" position.
  - 3-2.4.5.6.4 Except as provided in paragraphs 3-2.4.5.6.1, 3-2.4.5.6.3 and 3-2.4.5.6.5, the operation of the rear fog lamp(s) shall not be affected by switching on or off any other lamps.
  - 3-2.4.5.6.5 The rear fog lamp(s) of a drawing motor vehicle may be automatically switched off while a trailer is connected and the rear fog lamp(s) of the trailer is (are) activated.
- 3-2.4.5.7 The rear fog lamps device of stipulation one :
  - 3-2.4.5.7.1 The rear fog lamp can be one or two in quantity, positioned symmetrically on both sides of vehicle.
  - 3-2.4.5.7.2 The rear fog lamp is restricted by red.
  - 3-2.4.5.7.3 Unless the headlamp, front fog lamp, clearance/ front position lamp or trail/ rear position lamp is on, the rear fog lamp shall not be turned on alone. When the front fog lamp is equipped, the rear fog lamp shall be arranged that it could be turned off alone.
  - 3-2.4.5.7.4 The distance between the rear fog lamp center and stop lamp center shall be over 0.1 m.
- 3-2.4.6 Stop lamp:
  - 3-2.4.6.1 The stop lamp shall conform to requirements concerning "Stop-lamp" regulated in VSTD.
  - 3-2.4.6.2 Number: Two S1 or S2 category devices. Except the case where category S3 or S4 device is installed, two optional category S1 or S2 devices may be installed on vehicles in categories M2, M3, N2, N3, O2, O3, and O4.
    - 3-2.4.6.2.1 Grouped, combined or reciprocally incorporated lamps

The official directions are written in Chinese, this English edition is for your reference only.

- 3-2.4.6.2.1.1 Lamps may be grouped, combined or reciprocally incorporated with one another provided that all requirements regarding colour, position, orientation, geometric visibility, electrical connections and other requirements, if any, are fulfilled.
  - 3-2.4.6.2.1.1.1 However, where stop lamps and direction indicator lamps are grouped, any horizontal or vertical straight line passing through the projections of the apparent surfaces of these functions on a plane perpendicular to the reference axis, shall not intersect more than two borderlines separating adjacent areas of different colour.
  - 3-2.4.6.2.1.2 Where the apparent surface of a single lamp is composed of two or more distinct parts, it shall satisfy the following requirements: Either the total area of the projection of the distinct parts on a plane tangent to the exterior surface of the transparent material and perpendicular to the reference axis shall occupy not less than 60 per cent of the smallest quadrilateral circumscribing the said projection, or the distance between two adjacent/tangential distinct parts shall not exceed 15 mm when measured perpendicularly to the reference axis.
- 3-2.4.6.2.2 circumscribing the said projection, or the distance between two adjacent/tangential distinct parts shall not exceed 15 mm.
- 3-2.4.6.3 The colour of the light emitted by the lamps: red.
- 3-2.4.6.4 Position:
  - 3-2.4.6.4.1 In width:
    - 3-2.4.6.4.1.1 For M1 and N1 category vehicles: For S1 or S2 categories devices that point on the apparent surface in the direction of the reference axis which is farthest from the vehicle's median longitudinal plane shall not be more than 400 mm from the extreme outer edge of the vehicle;
    - 3-2.4.6.4.1.2 For all other categories of vehicles: For S1 or S2 categories devices the distance in between the inner edges of the apparent surfaces in the direction of the reference axes shall be not less than 600 mm. This distance may be reduced to 400 mm if the overall width of the vehicle is less than 1,300 mm.
  - 3-2.4.6.4.2 In height: For S1 or S2 categories devices: above the ground, not less than 350 mm nor more than 1,500 mm (2,100 mm if the shape of the bodywork makes it impossible to keep within 1,500 mm and if the optional lamps are not installed. If the optional lamps are installed, they shall be positioned at a height compatible with the requirements of the width and the symmetry of the lamps, and at a vertical distance as large as the shape of the bodywork makes it possible, but not less than 600 mm above the mandatory lamps.)
- 3-2.4.6.5 Geometric visibility:
  - 3-2.4.6.5.1 Horizontal angle: For S1 or S2 categories devices: 45 degrees to the left and to the right of the longitudinal axis of the vehicle;
  - 3-2.4.6.5.2 Vertical angle: For S1 or S2 categories devices: 15 degrees above and below the horizontal. However, the vertical angle below the horizontal may be reduced to 5 degrees, if the height of the lamp is less than 750 mm. The vertical angle above the horizontal may be reduced to 5 degrees in the case of optional lamps not less than 2,100 mm above the ground;
- 3-2.4.6.6 Orientation: Towards the rear of the vehicle.
- 3-2.4.6.7 Electrical connections: All stop lamps must be lighted up simultaneously when the braking system provides the relevant signal defined in regulation of 「Dynamic braking」. The stop lamps need not function if the device which starts and/or

The official directions are written in Chinese, this English edition is for your reference only.

- stops the engine is in a position which makes it impossible for the engine to operate.
- 3-2.4.6.8 Tell-tale: Tell-tale optional; where fitted, this tell-tale must be an operating tell-tale consisting of a non-flashing warning light which comes on in the event of the malfunctioning of the stop lamps.
  - 3-2.4.7 High mounted /S3 lamp:
    - 3-2.4.7.1 Devices of S3 category: one mandatory on M1 category of vehicles and the high mounted /S3 lamp shall conform to requirements concerning "High mounted /S3 lamp" regulated in VSTD, optional on other categories of vehicles.
    - 3-2.4.7.2 The colour of the light emitted by the lamps: red.
    - 3-2.4.7.3 Position: high mounted /S3 lamp can be installed in externally or internally of the motor vehicle.
      - 3-2.4.7.3.1 In width: For S3 category devices: the centre of reference shall be situated on the median longitudinal plane of the vehicle. However, in the case where the two devices of the S3 category are installed, they shall be positioned as close as possible to the median longitudinal plane, one on each side of this plane. In the case where one S3 category lamp offset from the median longitudinal plane is permitted, this offset shall not exceed 150 mm from the median longitudinal plane to the centre of reference of the lamp.
      - 3-2.4.7.3.2 In height: For S3 category devices, the horizontal plane tangential to the lower edge of the apparent surface shall: either not be more than 150 mm below the horizontal plane tangential to the lower edge of the exposed surface of the glass or glazing of the rear window, or not be less than 850 mm above the ground.
      - 3-2.4.7.3.3 However, the horizontal plane tangential to the lower edge of the apparent surface of S3 category device shall be above the horizontal plane tangential to the upper edge of the apparent surface of S1 or S2 categories devices specified in paragraph 3-2.4.6.
    - 3-2.4.7.4 Geometric visibility:
      - 3-2.4.7.4.1 Horizontal angle: For S3 category devices: 10 degrees to the left and to the right of the longitudinal axis of the vehicle;
      - 3-2.4.7.4.2 Vertical angle: For S3 category devices: 10 degrees above and 5 degrees below the horizontal.
    - 3-2.4.7.5 Electrical connections: Must light up when the service brake is applied. The stop lamps need not function if the device which starts and/or stops the engine is in a position which makes it impossible for the engine to operate.
    - 3-2.4.7.6 Tell-tale: Tell-tale optional; where fitted, this tell-tale must be an operating tell-tale consisting of a non-flashing warning light which comes on in the event of the malfunctioning of the stop lamps.
  - 3-2.4.8 Direction-indicator lamp: Optional on trailers' front direction-indicator lamp.
    - 3-2.4.8.1 The direction-indicator lamp shall conform to requirements concerning "Direction indicator" regulated in VSTD.
    - 3-2.4.8.2 The colour of the light emitted by the lamps: amber.
    - 3-2.4.8.3 Types of direction-indicator lamps fall into categories (1, 1a, 1b, 2a, 2b, 5 and 6) the assembly of which on one vehicle constitutes an arrangement ('A' and 'B') as Fig 3.
      - 3-2.4.8.3.1 Arrangement 'A' shall apply to all motor vehicles: 1, 1a, 1b, 2a, 2b, 5 and 6.
        - 3-2.4.8.3.1.1 Two front direction-indicator lamps of the following categories:
          - 3-2.4.8.3.1.1.1 1 or 1a or 1b, if the distance between the edge of the apparent surface in the direction of the reference axis of this lamp and that of the apparent surface in the direction of the reference axis of the dipped-beam headlamp and/or the front fog lamp, if there is one, is at least 40 mm;

The official directions are written in Chinese, this English edition is for your reference only.



- 3-2.4.8.3.1.1.2 1a or 1b, if the distance between the edge of the apparent surface in the direction of the reference axis of this lamp and that of the apparent surface in the direction of the reference axis of the dipped-beam headlamp and/or the front fog lamp, if there is one, is greater than 20 mm and less than 40 mm;
- 3-2.4.8.3.1.1.3 1b, if the distance between the edge of the apparent surface in the direction of the reference axis of this lamp and that of the apparent surface in the direction of the reference axis of the dipped-beam headlamp and/or the front fog lamp, if there is one, is less than or equal to 20 mm;
- 3-2.4.8.3.1.2 Two rear direction-indicator lamps (category 2a or 2b); two optional lamps (category 2a or 2b) on all vehicles in categories M2, M3, N2, N3;
- 3-2.4.8.3.1.3 Two side direction-indicator lamps of the categories:
  - 3-2.4.8.3.1.3.1 5, for all M1 vehicles; for N1, M2 and M3 vehicles not exceeding 6 m in length. It is permitted to replace category 5 side direction-indicator lamps by category 6 side direction-indicator lamps in all instances.
  - 3-2.4.8.3.1.3.2 6, for all N2 and N3 vehicles; for N1, M2 and M3 vehicles exceeding 6 m in length.
  - 3-2.4.8.3.1.3.3 For concerns of safety or specific operation, two or four optional side direction-indicator lamps (category 5 or 6) may be fitted symmetrically.
- 3-2.4.8.3.1.4 Where lamps combining the functions of front direction-indicator lamps (categories 1, 1a, 1b) and side direction-indicator lamps (categories 5 or 6) are fitted, two additional side direction-indicator lamps (categories 5 or 6) may be fitted to meet the visibility requirements.
- 3-2.4.8.3.1.5 The direction-indicator lamps shall according to 3-2.4.6.2.1 and 3-2.4.6.2.2 ◦
- 3-2.4.8.3.2 Arrangement 'B' shall apply to trailers only. Two rear direction-indicator lamps (categories 2a or 2b). Two or four optional lamps (category 2a or 2b) on all vehicles in categories O2, O3 and O4.
- 3-2.4.8.3.3 Where an AFS is fitted, the distance to be considered for the choice of the category is the distance between the front direction indicator lamp and the closest lighting unit in its closest position contributing to or performing a passing beam mode.
- 3-2.4.8.4 Position:
  - 3-2.4.8.4.1 In width: the edge of the apparent surface in the direction of the reference axis farthest from the median longitudinal plane of the vehicle must not be more than 400 mm from the extreme outer edge of the vehicle. This condition shall not apply to the optional rear lamps. The distance between the inner edges of the two apparent surfaces in the direction of the reference axes shall not be less than 600 mm. This distance may be reduced to 400 mm where the overall width of the vehicle is less than 1,300 mm.
  - 3-2.4.8.4.2 In height:
    - 3-2.4.8.4.2.1 The height of the light-emitting surface of the side direction-indicator lamps of categories 5 or 6 must not be: less than: 350 mm for M1 and N1 category of vehicles, and 500 mm for all other categories of vehicles, both measured from the lowest point; and more than: 1,500 mm, measured from the highest point.
    - 3-2.4.8.4.2.2 The height of the direction-indicator lamps of categories 1, 1a, 1b, 2a and 2b, shall not be less than 350

The official directions are written in Chinese, this English edition is for your reference only.



- mm or more than 1,500 mm.
- 3-2.4.8.4.2.3 If the structure of the vehicle does not permit these upper limits, measured as specified above, to be respected, and if the optional lamps are not installed, they may be increased to 2,300 mm for side direction-indicator lamps of categories 5 and 6, and to 2,100 mm for the direction-indicator lamps of categories 1, 1a, 1b, 2a and 2b.
- 3-2.4.8.4.2.4 If optional rear lamps are installed, they shall be placed at a height compatible with the applicable requirements of the symmetry of the lamps, and at a vertical distance as large as the shape of the bodywork makes it possible, but not less than 600 mm above the mandatory lamps.
- 3-2.4.8.4.3 In length: The distance between the light-emitting surface of the side direction-indicator lamp (categories 5 and 6) and the transverse plane which marks the forward boundary of the vehicle's overall length, shall not exceed 1,800 mm. However, this distance shall not exceed 2,500 mm:
- (a) for M1 and N1 category vehicles;
  - (b) for all other categories of vehicles if the structure of the vehicle makes it impossible to comply with the minimum angles of visibility.
- 3-2.4.8.5 Geometric visibility:
- 3-2.4.8.5.1 Horizontal angle: as shown in Fig 3 or, at the discretion of the manufacturer, for M1 and N1 category vehicles: Front and rear direction-indicator lamps, as well as side-marker lamps as shown in Fig 4. To be considered visible, the lamp must provide an unobstructed view of the apparent surface of at least 12.5 cm<sup>2</sup>, except for side direction-indicators of categories 5 and 6. The illuminating surface area of any retro-reflector that does not transmit light shall be excluded. The value of 5 degrees given for dead angle of visibility to the rear of the side direction-indicator is an upper limit.  $d < 1.80$  m (for M1 and N1 category vehicles  $d < 2.50$  m).

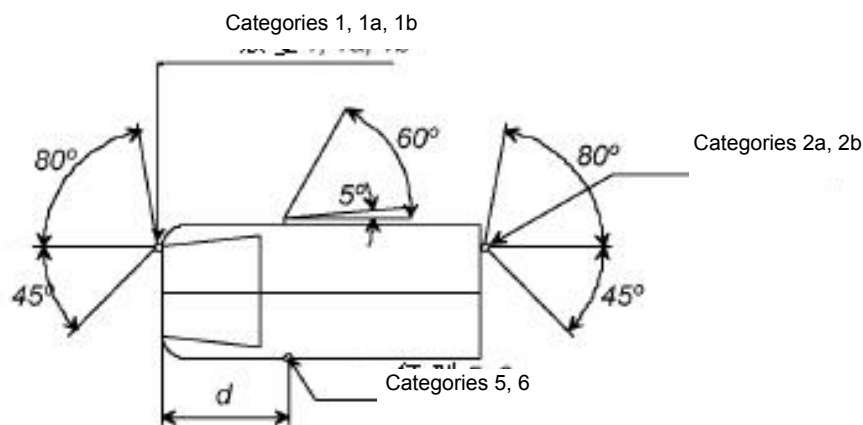

Arrangement A

The official directions are written in Chinese, this English edition is for your reference only.

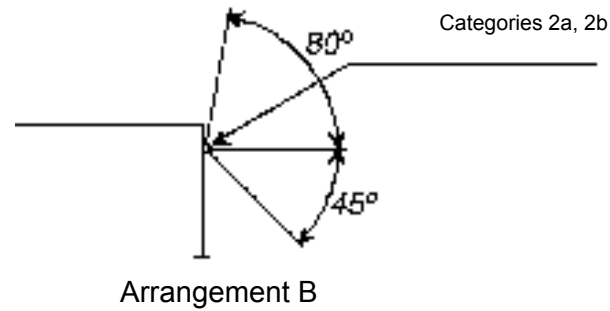

Fig 3. The visibility of direction-indicator lamp -- Horizontal angle

3-2.4.8.5.2 Vertical angles: 15 degrees above and below the horizontal for direction-indicator lamps of categories 1, 1a, 1b, 2a, 2b and 5. The vertical angle below the horizontal may be reduced to 5 degrees if the lamps are less than 750 mm above the ground; 30 degrees above and 5 degrees below the horizontal for direction-indicator lamps of category 6. The vertical angle above the horizontal may be reduced to 5 degrees if the optional lamps are not less than 2,100 mm above the ground.

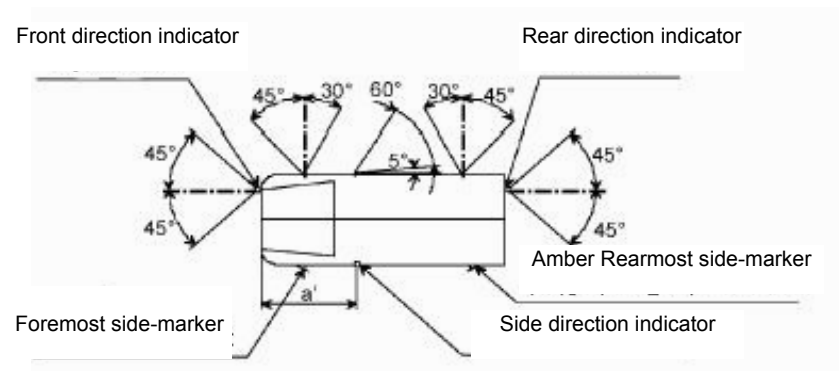

Fig 4. Horizontal angle of front/rear direction-indicator lamp and side-marker lamp

3-2.4.8.6 Electrical connections: Direction-indicator lamps shall switch on independently of the other lamps. All direction-indicator  
The official directions are written in Chinese, this English edition is for your reference only.

- lamps on one side of a vehicle shall be switched on and off by means of one control and shall flash in phase. On M1 and N1 vehicles less than 6 m in length, the amber side-marker lamps, when mounted, shall also flash at the same frequency (in phase) with the direction indicator lamps.
- 3-2.4.8.7 The light shall be a flashing light flashing 90 +/- 30 times per minute. Operation of the light-signal control shall be followed within not more than one second by the emission of light and within not more than one and one-half seconds by its first extinction.
- 3-2.4.8.8 Tell-tale:
- 3-2.4.8.8.1 Operating tell-tale mandatory for direction indicator lamps of categories 1, 1a, 1b, 2a and 2b. It may be visual or auditory or both. If it is visual it shall be a flashing light which, at least in the event of the malfunction of any of these direction indicator lamps, is either extinguished, or remains alight without flashing, or shows a marked change of frequency. If it is entirely auditory it shall be clearly audible and shall show a marked change of frequency, at least in the event of the malfunction of any of these direction indicator lamps.
- 3-2.4.8.8.2 It shall be activated by the signal produced according to "Direction indicator" regulated in "Directions" or another suitable way."
- 3-2.4.8.8.3 If a motor vehicle is equipped to draw a trailer, it must be fitted with a special visual operational tell-tale for the direction-indicator lamps on the trailer unless the tell-tale of the drawing vehicle allows the failure of any one of the direction-indicator lamps on the vehicle combination thus formed to be detected.
- 3-2.4.8.8.4 For the optional pair of direction-indicator lamps on trailers, operating tell-tale shall not be mandatory.
- 3-2.4.9 Rear registration plate lamp:
- 3-2.4.9.1 The colour of the light emitted by the lamps: white.
- 3-2.4.9.2 The lamp shall be installed at the upper, lower, right or left side of the rear registration plate.
- 3-2.4.9.3 The lamp shall be properly shielded, and its light model, shall not affect the vehicles coming from backside.
- 3-2.4.9.4 Electrical connections: The electrical connections must be such that the front and rear position lamps, the end-outline marker lamps, if they exist, the side-marker lamps, if they exist, and the rear registration plate lamp can only be switched on and off simultaneously. This condition does not apply when using front and rear position lamps, as well as side-marker lamps when combined or reciprocally incorporated with said lamps, as parking lamps and when side-marker lamps are permitted to flash.
- 3-2.4.10 Reversing lamp: Mandatory on M, N, O2, O3 and O4. Optional on O1.
- 3-2.4.10.1 One device mandatory and a second device optional on motor vehicles of category M1 and on all other vehicles with a length not exceeding 6,000 mm.
- 3-2.4.10.2 Two devices mandatory and two devices optional on all vehicles with a length exceeding 6,000 mm, except vehicles of category M1.
- 3-2.4.10.3 The colour of the light emitted by the lamps: white.
- 3-2.4.10.4 In height: within 250 mm and 1,200 mm above the ground.
- 3-2.4.10.5 In length: at the back of the vehicle.
- 3-2.4.10.6 Geometric visibility: 15 degrees upwards and 5 degrees downwards, 45 degrees to right and to left if there is only one light, 45 degrees outwards and 30 degrees inwards if there are two. In case of conform to requirements concerning "front fog

The official directions are written in Chinese, this English edition is for your reference only.

- lamps” regulated in VSTD: 5 degrees upwards and downwards, 45 degrees outwards and inwards if there is only one lamp 45 degrees outwards and 10 degrees inwards if there are two lamps.
- 3-2.4.10.7 Orientation: Rearwards or rear-sideways. In the case of the two optional devices mentioned in paragraph 3-2.4.10.2, if fitted on the side of the vehicle, the requirements of geometric visibility in paragraph 3-2 4.10.6. shall not be applied. However, the reference axis of these devices shall be orientated outwards not more than 15 degrees horizontally towards the rear in relation to the median longitudinal plane of the vehicle.
- 3-2.4.10.8 They shall be such that the lamp can light up only if the reverse gear is engaged and if the device which controls the starting and stopping of the engine is in such a position that operation of the engine is possible. It shall not light up or remain lit if either of the above conditions is not satisfied.  
Moreover, the electrical connections of the two optional devices shall be such that these devices cannot illuminate unless the lamps are switched on.  
The devices fitted on the side of the vehicle may be switched on for slow manoeuvres in forward motion of the vehicle up to a maximum speed of 10 km/h, provided that the following conditions are fulfilled:  
(a) the devices shall be activated and deactivated manually by a separate switch;  
(b) if the switch is activated, they may remain illuminated if the reverse gear is disengaged;  
(c) they shall be automatically switched off if the forward speed of the vehicle exceeds 10 km/h, regardless of the position of the separate switch; in this case they shall remain switched off until deliberately being switched on again.
- 3-2.4.11 Hazard warning signal:
- 3-2.4.11.1 means the simultaneous operation of all of a vehicle's direction-indicator lamps.
- 3-2.4.11.2 Electrical connections:
- 3-2.4.11.2.1 The signal shall be operated by means of a separate control enabling all the direction indicator lamps to flash in phase.
- 3-2.4.11.2.2 The hazard warning signal may be activated automatically in the event of a vehicle being involved in a collision or after the de-activation of the emergency stop signal, as specified in paragraph 3-2.6.17. In such cases, it may be turned "off" manually.
- 3-2.4.11.2.3 On M1 and N1 vehicles less than 6 m in length, with an arrangement complying with paragraph 3-2.4.8.5 above, the amber side-marker lamps, when mounted, shall also flash at the same frequency (in phase) with the direction indicator lamps.
- 3-2.4.11.3 Tell-tale: Circuit-closed tell-tale mandatory. Flashing warning light, which can operate in conjunction with the tell-tale(s).
- 3-2.4.11.4 If a power-driven vehicle is equipped to draw a trailer the hazard warning signal control shall also be capable of bringing the direction indicator lamps on the trailer into action.
- 3-2.4.11.5 The hazard warning signal shall be able to function even if the device which starts or stops the engine is in a position which makes it impossible to start the engine.
- 3-2.4.12 Top lamp of commercial passenger vehicle:
- 3-2.4.12.1 The lamp should be single lamp.
- 3-2.4.12.2 The colour of the light emitted by the lamps: not be red.
- 3-2.4.12.3 Using bolt (the drilling type isn't restricted), metal pressing-stripe or roof frame to fix the lamp at the proper location of roof's

The official directions are written in Chinese, this English edition is for your reference only.

front half. Magnetic connection is not allowed.

3-2.4.12.4 The lamp's switch should be connected to interact with the charge counter.

3-2.4.13 Rear retro-reflector, non-triangular: Mandatory on motor vehicles. Provided that they are grouped together with the other rear light-signalling devices, optional on trailers.

3-2.4.13.1 Number: Two, the performances of which shall conform to the requirements of "Retro-reflector" concerning Class IA or IB retro-reflectors regulated in VSTD. If it doesn't influence lights and reflectors' effectiveness that it allow additionally installed retro-reflector and retro-reflective material. (including two retro-reflectors not specified in paragraph 3-2.4.13.3 below),

3-2.4.13.2 The colour of the light emitted by the lamps: red.

3-2.4.13.3 Position: In length: at the rear of the vehicle.

3-2.4.13.3.1 In width: that point on the illuminating surface which is farthest from the vehicle's median longitudinal plane shall not be more than 400 mm from the extreme outer edge of the vehicle. The distance between the inner edges of the two apparent surfaces in the direction of the reference axes shall: For M1 and N1 category vehicles: have no special requirement; For all other categories of vehicles: be not less than 600 mm. This distance may be reduced to 400 mm where the overall width of the vehicle is less than 1,300 mm.

3-2.4.13.3.2 In height: above the ground, not less than 250 mm nor more than 900 mm (1,500 mm if the shape of the bodywork makes it impossible to keep within 900 mm).

3-2.4.13.4 Geometric visibility:

3-2.4.13.4.1 Horizontal angle: 30 degrees inwards and outwards.

3-2.4.13.4.2 Vertical angle: 10 degrees above and below horizontal. The vertical angle below the horizontal may be reduced to 5 degrees in the case of a retro-reflector less than 750 mm above the ground.

3-2.4.14 Rear retro-reflector, triangular: Mandatory on trailers. Prohibited on motor vehicles.

3-2.4.14.1 Number: Two, the performances of which shall conform to the requirements of "Retro-reflector" concerning Class IIIA retro-reflectors regulated in VSTD. If it doesn't influence lights and reflectors' effectiveness that it allow additionally installed retro-reflector and retro-reflective material. (including two retro-reflectors not specified in paragraph 3-2.4.14.3 below),

3-2.4.14.2 The colour of the light emitted by the lamps: red.

3-2.4.14.3 Position: In length: at the rear of the vehicle. The apex of the triangle shall be directed upwards.

3-2.4.14.3.1 In width: that point on the illuminating surface which is farthest from the vehicle's median longitudinal plane shall not be more than 400 mm from the extreme outer edge of the vehicle. The inner edges of the retro-reflectors shall not be less than 600 mm apart. This distance may be reduced to 400 mm if the overall width of the vehicle is less than 1,300 mm.

3-2.4.14.3.2 In height: above the ground, not less than 250 mm nor more than 900 mm (1,500 mm if the shape of the bodywork makes it impossible to keep within 900 mm).

3-2.4.14.4 Geometric visibility:

3-2.4.14.4.1 Horizontal angle: 30 degrees inwards and outwards.

3-2.4.14.4.2 Vertical angle: 15 degrees above and below the horizontal. The vertical angle below the horizontal may be reduced to 5 degrees in the case of a retro-reflector less than 750 mm above the ground.

3-2.4.14.5 The illuminating surface of the retro-reflector may have parts in common with the apparent surface of any other lamp

situated at the rear.

3-2.4.15 Front retro-reflector, non-triangular: Mandatory on trailers. Mandatory on motor vehicles having all forward facing lamps with reflectors concealable. Optional on other motor vehicles.

3-2.4.15.1 Number: Two, the performances of which shall conform to the requirements of "Retro-reflector" concerning Class IA or IB retro-reflectors regulated in VSTD. If it doesn't influence lights and reflectors' effectiveness that it allow additionally installed retro-reflector and retro-reflective material. (including two retro-reflectors not specified in paragraph 3-2.4.15.3 below),

3-2.4.15.2 Color: identical to incident light (i.e., white or colorless).

3-2.4.15.3 Position: In length: at the front of the vehicle.

3-2.4.15.3.1 In width: that point on the illuminating surface which is farthest from the vehicle's median longitudinal plane shall not be more than 400 mm from the extreme outer edge of the vehicle. In the case of a trailer, the point of the illuminating surface which is farthest from the vehicle's median longitudinal plane shall not be farther than 150 mm from the extreme outer edge of the vehicle. The distance between the inner edges of the two apparent surfaces in the direction of the reference axes shall: For M1 and N1 category vehicles: have no special requirement; For all other categories of vehicles: be not less than 600 mm. This distance may be reduced to 400 mm where the overall width of the vehicle is less than 1,300 mm.

3-2.4.15.3.2 In height: above the ground, not less than 250 mm nor more than 900 mm (1,500 mm if the shape of the bodywork makes it impossible to keep within 900 mm).

3-2.4.15.3.3 Geometric visibility:

3-2.4.15.3.3.1 Horizontal angle: 30 degrees inwards and outwards. In the case of trailers, the angle inwards may be reduced to 10 degrees. If because of the construction of the trailers this angle cannot be met by the mandatory retro-reflectors, then additional (supplementary) retro-reflectors shall be fitted, without the width limitation (paragraph 3-2.4.15.3.1), which shall, in conjunction with the mandatory retro-reflectors, give the necessary visibility angle.

3-2.4.15.3.3.2 Vertical angle: 10 degrees above and below the horizontal. The vertical angle below the horizontal may be reduced to 5 degrees in the case of a retro-reflector less than 750 mm above the ground.

3-2.4.16 Side retro-reflector, non-triangular: Mandatory: On all motor vehicles the length of which exceeds 6 m. On all trailers. Optional: On motor vehicles the length of which does not exceed 6 m.

3-2.4.16.1 The performances of these devices shall conform to the requirements of "Retro-reflector" concerning Class IA or IB retro-reflectors regulated in VSTD. If it doesn't influence lights and reflectors' effectiveness that it allow additionally installed retro-reflector and retro-reflective material. (including two retro-reflectors not specified in paragraph 3-2.4.16.3 below),

3-2.4.16.2 Color: amber; however the rearmost side retro-reflector can be red if it is grouped or has part of the light emitting surface in common with the rear position lamp, the rear end-outline marker lamp, the rear fog lamp, the stop-lamp, the red rearmost side-marker lamp or the rear retro-reflector, non- triangular.

3-2.4.16.3 Position: Side of vehicle.

3-2.4.16.3.1 In height: above the ground, not less than 250 mm nor more than 900 mm (1,500 mm if the shape of the bodywork makes it impossible to keep within 900 mm).

3-2.4.16.3.2 In length:



- 3-2.4.16.3.2.1 At least one side retro-reflector must be fitted to the middle third of the vehicle, the foremost side retro-reflector being not further than 3 m from the front; in the case of trailers, account shall be taken of the length of the drawbar for the measurement of this distance.
- 3-2.4.16.3.2.2 The distance between two adjacent side retro-reflectors shall not exceed 3 m. This does not, however, apply to M1 and N1 category vehicles. If the structure of the vehicle makes it impossible to comply with such a requirement, this distance may be increased to 4 m. The distance between the rearmost side retro-reflector and the rear of the vehicle shall not exceed 1 m.
- 3-2.4.16.3.2.3 However, for motor vehicles the length of which does not exceed 6 m, it is sufficient to have one side retro-reflector fitted within the first third and/or one within the last third of the vehicle length.
- 3-2.4.16.4 Geometric visibility:
  - 3-2.4.16.4.1 Horizontal angle: 45 degrees to the front and to the rear.
  - 3-2.4.16.4.2 Vertical angle: 10 degrees above and below the horizontal. The vertical angle below the horizontal may be reduced to 5 degrees in the case of a retro-reflector less than 750 mm above the ground.
- 3-2.4.17 Side-marker lamp:
  - 3-2.4.17.1 Mandatory: On all vehicles the length of which exceeds 6 m, except for chassis-cabs; the length of trailers shall be calculated including the drawbar. The SM1 type of side-marker lamp shall be used on all categories of vehicles, and the side-marker lamp shall conform to requirements concerning "Side-marker lamp" regulated in VSTD; however the SM2 type of side-marker lamps may be used on the M1 category of vehicles.
  - 3-2.4.17.2 In addition, on M1 and N1 category vehicles less than 6 m in length, side-marker lamps shall be used, if they supplement the reduced geometric visibility requirements of front position lamps conforming to paragraph 3-2.4.3.4.3 and rear position lamps conforming to paragraph 3-2.4.4.3. Optional: On all other vehicles. The SM1 or SM2 types of side-marker lamps may be used and shall conform to requirements concerning "Side-marker lamp" regulated in VSTD.
  - 3-2.4.17.3 The side-marker lamp fitted to other motor vehicles, shall conform to requirements concerning "Side-marker lamp" regulated in VSTD.
  - 3-2.4.17.4 Color: amber; however the rearmost side-marker lamp can be red if it is grouped or combined or reciprocally incorporated with the rear position lamp, the rear end-outline marker lamp, the rear fog lamp, the stop lamp or is grouped or has part of the light emitting surface in common with the rear retro-reflector.
  - 3-2.4.17.5 Position:
    - 3-2.4.17.5.1 In height: above the ground, not less than 250 mm nor more than 1,500 mm (2,100 mm if the shape of the bodywork makes it impossible to keep within 1,500 mm).
    - 3-2.4.17.5.2 In length:
      - 3-2.4.17.5.2.1 At least one side-marker lamp must be fitted to the middle third of the vehicle, the foremost side-marker lamp being not further than 3 m from the front; in the case of trailers account shall be taken of the length of the drawbar for the measurement of this distance.
      - 3-2.4.17.5.2.2 The distance between two adjacent side-marker lamps shall not exceed 3 m. If the structure of the vehicle makes it impossible to comply with such a requirement, this distance may be increased to 4 m. The distance between the rearmost side-marker lamp and the rear of the vehicle shall not exceed 1 m.



- 3-2.4.17.5.2.3 However, for vehicles the length of which does not exceed 6 m and for chassis-cabs, it is sufficient to have one side-marker lamp fitted within the first third and/or within the last third of the vehicle length.
- 3-2.4.17.6 Geometric visibility:
- 3-2.4.17.6.1 Horizontal angle: 45 degrees to the front and to the rear; however for vehicles on which the installation of the side-marker lamps is optional this value can be reduced to 30 degrees. If the vehicle is equipped with side-marker lamps used to supplement the reduced geometric visibility of front and rear direction indicator lamps conforming to Fig.4 of paragraph 3-2.4.8.5 and/or position lamps conforming to paragraphs 3-2.4.3.4.3 and 3-2.4.4.4.3, the angles are 45 degrees towards the front and rear ends of the vehicle and 30 degrees towards the centre of the vehicle.
- 3-2.4.17.6.2 Vertical angle: 10 degrees above and below the horizontal. The vertical angle below the horizontal may be reduced to 5 degrees in the case of a side-marker lamp less than 750 mm above the ground.
- 3-2.4.17.7 Orientation: Towards the side.
- 3-2.4.17.8 Electrical connections: On M1 and N1 category vehicles less than 6 m in length amber side-marker lamps may be wired to flash, provided that this flashing is in phase and at the same frequency with the direction indicator lamps at the same side of the vehicle.
- 3-2.4.17.9 Tell-tale: optional. If it exists its function shall be carried out by the tell-tale required for the front and rear position lamps.
- 3-2.4.18 End outline marker lamp: Mandatory on vehicle exceeding 2.10 m in width. Optional on vehicles between 1.80 and 2.10 m in width.
- 3-2.4.18.1 Number: Two, and the end outline marker lamp shall conform to requirements concerning "End outline marker lamp", "Front position lamps" or "Rear position lamps" regulated in VSTD, and visible from the front and two visible from the rear.  
Optional: additional lamps may be fitted as follows:  
(a) two visible from the front;  
(b) two visible from the rear.
- 3-2.4.18.2 The colours of the light emitted by the lamps: white in front, red at the rear.
- 3-2.4.18.3 Position:
- 3-2.4.18.3.1 In width: Front and rear: as close as possible to the extreme outer edge of the vehicle. This condition is deemed to have been met when the point on the apparent surface in the direction of the reference axis which is farthest from the vehicle's median longitudinal plane is not more than 400 mm from the extreme outer edge of the vehicle.
- 3-2.4.18.3.2 In height:
- 3-2.4.18.3.2.1 Front: Motor vehicles - the horizontal plane tangential to the upper edge of the apparent surface in the direction of the reference axis of the device must not be lower than the horizontal plane tangential to the upper edge of the transparent zone of the wind-screen.  
Trailers and semi-trailers - at the maximum height compatible with the requirements relating to the width, design and operational requirements of the vehicle and to the symmetry of the lamps.
- 3-2.4.18.3.2.2 Rear: At the maximum height compatible with the requirements relating to the width, design and operational requirements of the vehicle and to the symmetry of the lamps.  
Both optional and mandatory (as applicable) lamps to be fitted as far separated in height as practicable and compatible with design/operational requirements of the vehicle and symmetry of the lamps.
- 3-2.4.18.3.3 In length, no special requirement.

The additional lamps visible from the front, as specified in paragraph 3-2.4.18.3.2, as close as practicable to the rear. However, the distance between the additional lamps and the rear of the vehicle shall not exceed 400 mm.

3-2.4.18.4 Geometric visibility:

3-2.4.18.4.1 Horizontal angle: 80 degrees outwards.

3-2.4.18.4.2 Vertical angle: 5 degrees above and 20 degrees below the horizontal.

3-2.4.18.5 Electrical connections: The electrical connections must be such that the front and rear position lamps, the end-outline marker lamps, the side-marker lamps, if they exist, and the rear registration plate lamp can only be switched on and off simultaneously. This condition does not apply when using front and rear position lamps, as well as side-marker lamps when combined or reciprocally incorporated with said lamps, as parking lamps and when side-marker lamps are permitted to flash.

3-2.4.18.6 Tell-tale: Tell-tale optional. If it exists, its function shall be carried out by the tell-tale required for the front and rear position lamps.

3-2.4.18.7 Other requirements :

3-2.4.18.7.1 Provided that all other requirements are met, the mandatory or optional lamps, visible from the front and the mandatory or optional lamps visible from the rear on the same side of the vehicle may be combined into one device.

Two of the lamps visible from the rear may be grouped, combined or reciprocally incorporated.

The position of an end-outline marker lamp in relation to corresponding position lamp shall be such that the distance between the projections on a transverse vertical plane of the points nearest to one another on the apparent surfaces in the direction of the respective reference axes of the two lamps considered is not less than 200 mm.

3-2.4.18.7.2 Those who assembled front mirror's vehicle and the end outline marker lamp that stand with front mirror the same side can except for paragraph 3-2.4.1.8.4, but the others end outline marker lamp shall comply with paragraph 3-2.4.1.8.4.

3-2.4.19 Requirements for lamps and movable components :

3-2.4.19.1 Rear position lamps, rear direction-indicators and rear retro-reflectors (triangular as well as non triangular) may be installed on

movable components in the following conditions:

3-2.4.19.1.1 At any fixed position of the movable components, the position of installation, geometric visibility and photometric requirements for those lamps shall meet the requirements. Should the above functions be obtained by an assembly of two lamps marked "D", only one of these lamps needs to meet the above-mentioned requirements; or

3-2.4.19.1.2 where additional lamps for the above functions are fitted and can be activated at any fixed position, the position of installation, geometric visibility and photometric requirements of the lamps shall meet the requirements applicable to the lamps installed on the movable component.

3-2.4.19.2 When the movable components are in a position other than a "normal position of use", the lamps installed on the movable components shall not cause discomfort to other road users.

3-2.4.19.3 When the lamp is installed on a movable component and the movable component is in the "normal position(s) of use", the lamp must always return to the position(s) to comply with this Regulation specified by the manufacturer. In the case of dipped-beam headlamps and front fog lamps, this requirement shall be considered satisfactory if, when the movable components are moved and returned to the normal position 10 times, no value of the angular inclination of these lamps, relative to its support,

The official directions are written in Chinese, this English edition is for your reference only.

measured after each operation of the movable component, differs by more than 0.15 per cent from the average of the 10 measured values. If above requirement can not be met, when conducting perpendicular illuminating test for dipped-beam lamps, the exceeding value shall be corrected for the limit values according to paragraph 3-2.4.2.5.1.1 to reduce the allowable range of inclinations.

3-2.4.19.4 The apparent surface in the direction of the reference axis of front and rear position lamps, front and rear direction-indicator lamps and retro-reflectors shall not be hidden for more than 50 per cent on any movable component, with or without a light-signalling device installed on it, in any fixed position from the "use range". If the above requirement can not be met, shall follow at least one of the requirements as below:

3-2.4.19.4.1 Additional lamps satisfying the installation position, geometric visibility and photometric requirements for the above indicated lamps shall be activated when the apparent surface in the direction of the reference axis of these lamps is hidden by the movable component for more than 50 per cent ; or

3-2.4.19.4.2 a remark that more than 50 percent of the apparent surface in the direction of the reference axis can be hidden by the movable components shall be specified in the test report.; and a notice in the vehicle shall inform the driver that in specific position(s) of the movable components other road users shall be warned of the presence of the vehicle on the road; for example by means of a warning triangle or other devices according to national requirements for use on the road. This stipulation does not apply to retro-reflectors ; or

3-2.4.19.4.3 Additional installed retro-reflective markings that conform to this regulation..

3-2.4.20 Rear direction indicator lamps, rear position lamps, stop lamps (except stop lamps of category S4) and rear fog lamps with variable luminous intensity control are allowed, which respond simultaneously to at least one of the following external influences: ambient lighting, fog, snowfall, rain, spray, dust clouds, contamination of the light emitting surface, provided that their prescribed intensity relationship is maintained throughout variation transitions. No sharp variation of intensity shall be observed during transition. Stop lamps of category S4 may produce variable luminous intensity independent from the other lamps. It may be possible for the driver to set the functions above to luminous intensities corresponding to their steady category and to return them to their automatic variable category.

3-2.4.21 In the absence of specific instructions, the photometric characteristics (e.g. intensity, colour, apparent surface, etc.) of a lamp shall not be intentionally varied during the period of activation of the lamp.

3-2.4.21.1 Direction-indicator lamps, the vehicle-hazard warning signal, amber side-marker lamps complying with paragraph 6.18.7. below, and the emergency stop signal shall be flashing lamps.

3-2.4.21.2 The photometric characteristics of any lamp may vary in the following condition:

(a) to react to the ambient light;

(b) as a consequence of the activation of other lamps, or

(c) when the lamps is being used to provide another lighting function,

provided that any variation in the photometric characteristics is in compliance with the technical provisions for the lamp concerned.

3-2.5 In the case of motorcycles

3-2.5.1 Driving beam headlamp: Mandatory on L3 and L5. Optional on L1 and L2.

3-2.5.1.1 Number: One or two symmetrically, and the driving beam headlamp shall conform to requirements concerning "Headlamps"

The official directions are written in Chinese, this English edition is for your reference only.

- or “Gas-discharge Headlamps” regulated in VSTD.
- 3-2.5.1.1.1 The exhaust amount  $\leq 125 \text{ cm}^3$  of L3 and L5 category motorcycles : shall be two lamps or four lamps installed symmetrically.
- 3-2.5.1.1.1.1 For class B、C and D of symmetrical-beam headlamps ◦
- 3-2.5.1.1.1.2 Asymmetrical-beam headlamp ◦
- 3-2.5.1.1.2 The exhaust amount  $> 125 \text{ cm}^3$  of L3 and L5 category motorcycles :
- 3-2.5.1.1.2.1 Who installed one or two symmetrically :
- 3-2.5.1.1.2.1.1 For class B or D of symmetrical-beam headlamps ◦
- 3-2.5.1.1.2.1.2 Asymmetrical-beam headlamp ◦
- 3-2.5.1.1.2.2 Four lamps installed symmetrically : For class C of symmetrical-beam headlamps ◦
- 3-2.5.1.1.3 L1 and L2 category motorcycles : shall be two lamps or four lamps installed symmetrically.
- 3-2.5.1.1.3.1 Symmetrical-beam headlamps ◦
- 3-2.5.1.1.3.2 For class A of asymmetrical-beam headlamps ◦
- 3-2.5.1.2 The colours of the lights: shall be white. The two lamps installed therein shall have the identical color.
- 3-2.5.1.3 Position:
- 3-2.5.1.3.1 Width:
- 3-2.5.1.3.1.1 an independent driving lamp may be fitted above or below or to one side of another front lamp: if these lamps are on top of the other the reference centre of the driving lamp must be located within the median longitudinal plane of the vehicle; if these lamps are side by side their reference centre must be symmetrical in relation to the median longitudinal plane of the vehicle.
- 3-2.5.1.3.1.2 a driving beam headlamp, that is reciprocally incorporated with another front lamp, must be fitted in such a way that its reference centre lies within the median longitudinal plane of the vehicle. However, when the vehicle is also fitted with an independent passing beam headlamp, or a passing beam headlamp that is reciprocally incorporated with a front position lamp alongside the driving beam headlamp, their reference centres must be symmetrical in relation to the median longitudinal plane of the vehicle.
- 3-2.5.1.3.1.3 two driving lamps of which either one or both are reciprocally incorporated with another front lamp must be fitted in such a way that their reference centres are symmetrical in relation to the median longitudinal plane of the vehicle.
- 3-2.5.1.3.2 The length: at the front of the vehicle. This requirement is regarded as satisfied if the light emitted does not cause discomfort to the driver either directly or indirectly by means of the rear-view mirrors and/or reflective surfaces on the vehicle.
- 3-2.5.1.3.3 In any case, the distance between the edge of the illumination surface of any independent driving lamp and the edge of that of the passing lamp must not exceed 200 mm.
- 3-2.5.1.3.4 The distance between the edge of the illuminating surface of any independent driving lamp and the ground must be from 500 mm to 1,300 mm.
- 3-2.5.1.3.5 In the case of two driving lamps: the distance separating the illuminating surfaces of two driving lamps must not

- exceed 200 mm.
- 3-2.5.1.4 The visibility of the illuminating surface, including its visibility in areas which do not appear to be illuminated in the direction of observation considered, shall be ensured within a divergent space defined by generating lines based on the perimeter of the illuminating surface and forming an angle of not less than 5 degrees with the axis of reference of the headlamp.
  - 3-2.5.1.5 Orientation: Forwards. The lamp(s) may move with the steering angle.
  - 3-2.5.1.6 Electrical connections: The headlamp may automatically be switched on when the engine is running and the passing beam(s) may remain illuminated with the driving beam(s).
  - 3-2.5.1.7 "Circuit-closed" tell-tale: Mandatory, non-flashing blue signal lamp.
- 3-2.5.2 Passing beam headlamp:
- 3-2.5.2.1 Number: One or two symmetrically, and the passing beam headlamp shall conform to requirements concerning "Headlamps" or "Gas-discharge Headlamps" regulated in VSTD.
    - 3-2.5.2.1.1 The exhaust amount  $\leq 125 \text{ cm}^3$  of L3 and L5 category motorcycles : shall be two lamps or four lamps installed symmetrically.
      - 3-2.5.2.1.1.1 For class B、C and D of symmetrical-beam headlamps ◦
      - 3-2.5.2.1.1.2 Asymmetrical-beam headlamp ◦
    - 3-2.5.2.1.2 The exhaust amount  $> 125 \text{ cm}^3$  of L3 and L5 category motorcycles :
      - 3-2.5.2.1.2.1 Who installed one or two symmetrically :
        - 3-2.5.2.1.2.1.1 For class B or D of symmetrical-beam headlamps ◦
        - 3-2.5.2.1.2.1.2 Asymmetrical-beam headlamp ◦
      - 3-2.5.2.1.2.2 Four lamps installed symmetrically : For class C of symmetrical-beam headlamps ◦
    - 3-2.5.2.1.3 L1 and L2 category motorcycles : shall be two lamps or four lamps installed symmetrically.
      - 3-2.5.2.1.3.1 Symmetrical-beam headlamps ◦
      - 3-2.5.2.1.3.2 For class A of asymmetrical-beam headlamps ◦
  - 3-2.5.2.2 The colours of the lights: shall be white. The two lamps installed therein shall have the identical color.
  - 3-2.5.2.3 Position:
    - 3-2.5.2.3.1 Width:
      - 3-2.5.2.3.1.1 an independent passing lamp may be installed above, below or to one side of another front lamp: if these lamps are one above the other the reference centre of the passing lamp must be located within the median longitudinal plane of the vehicle; if these lamps are side by side their reference centre must be symmetrical in relation to the median longitudinal plane of the vehicle.
      - 3-2.5.2.3.1.2 a passing beam headlamp, that is reciprocally incorporated with another front lamp, must be fitted in such a way that its reference centre lies within the median longitudinal plane of the vehicle; However, when the vehicle is also fitted with an independent driving beam headlamp, or a driving beam headlamp that is reciprocally incorporated with a front position lamp alongside the passing beam headlamp, their reference centers must be symmetrical in relation to the median longitudinal plane of the vehicle.
      - 3-2.5.2.3.1.3 two passing lamps, of which either one or both are reciprocally incorporated with another front lamp must

- be installed in such a way that their reference centres are symmetrical in relation to the median longitudinal plane of the vehicle.
- 3-2.5.2.3.2 Height: a minimum of 500 mm and a maximum of 1,200 mm above the ground.
  - 3-2.5.2.3.3 Length: at the front of the vehicle. This requirement is regarded as satisfied if the light emitted does not cause discomfort to the driver either directly or indirectly by means of the rear-view mirrors and/or reflective surfaces of the vehicle.
  - 3-2.5.2.3.4 In the case of two passing lamps the distance separating the illuminating surfaces must not exceed 200 mm. In the case of category vehicles L2 and L5 with two main-beam headlamps, the edges of the illuminating surfaces furthest from the median longitudinal plane of the vehicle must not be more than 400 mm from the outermost edge of the vehicle, the internal edges of the illuminating surfaces must be at least 400 mm apart.
  - 3-2.5.2.4 Geometric visibility:
    - 3-2.5.2.4.1 Horizontal angle: 45 degrees to the left and to the right for a single lamp; 45 degrees outwards and 10 degrees inwards for each pair of lamps.
    - 3-2.5.2.4.2 Vertical angle: 15 degrees upwards and 10 degrees downwards;
  - 3-2.5.2.5 Orientation: Forwards. The lamp(s) may move in line with the steering angle. The vertical inclination of the passing beam headlamp must remain between -0.5 and -2.5 percent, except in the case where an external adjusting device is present.
  - 3-2.5.2.6 Electrical connections: The headlamp may automatically be switched on when the engine is running and the control for passing beam(s) shall be switched off when changing over to the driving beam(s)..
  - 3-2.5.2.7 Tell-tale: Optional; non-flashing green signal lamp.
  - 3-2.5.3 Rear position lamp:
    - 3-2.5.3.1 Number: One or two, and the rear position lamp shall conform to requirements concerning "Tail lamps (rear position (side) lamps)" regulated in VSTD.
    - 3-2.5.3.2 (The colours of the lights: red.
    - 3-2.5.3.3 Position: in height: not less than 250 mm nor more than 1,500 mm above the ground; In the case of L2 and L5 category vehicles, the reference centre must be located within the median longitudinal plane of the vehicle if there is only one position lamp; if there are two position lamps these must be symmetrical to the median longitudinal plane of the vehicle. In the case of vehicles with two rear wheels: at least 400 mm between the two lamps.
    - 3-2.5.3.4 Geometric visibility:
      - 3-2.5.3.4.1 Horizontal angle: 80 degrees to left and to right for a single lamp: the horizontal angle may be 80 degrees outwards and 45 degrees inwards for each pair of lamps.
      - 3-2.5.3.4.2 Vertical angle: 15 degrees above and below the horizontal. The vertical angle below the horizontal may be reduced to 5 degrees , however, if the height of the lamp is less than 750 mm.
    - 3-2.5.3.5 Orientation: Rearwards.
    - 3-2.5.3.6 "Circuit-closed" tell-tale: Optional: Its function shall be performed by the device prescribed for the front position lamp.
  - 3-2.5.4 Stop lamp:
    - 3-2.5.4.1 Number: One or two, and the stop lamp shall conform to requirements concerning "Stop lamp" regulated in VSTD.
      - 3-2.5.4.1.1 Grouped, combined or reciprocally incorporated lamps

The official directions are written in Chinese, this English edition is for your reference only.



- 3-2.5.4.1.1.1 Lamps may be grouped, combined or reciprocally incorporated with one another provided that all requirements regarding colour, position, orientation, geometric visibility, electrical connections and other requirements, if any, are fulfilled.
- 3-2.5.4.1.1.1.1 However, where stop lamps and direction indicator lamps are grouped, any horizontal or vertical straight line passing through the projections of the apparent surfaces of these functions on a plane perpendicular to the reference axis, shall not intersect more than two borderlines separating adjacent areas of different colour.
- 3-2.5.4.1.2 Where the apparent surface of a single lamp is composed of two or more distinct parts, it shall satisfy the following requirements: Either the total area of the projection of the distinct parts on a plane tangent to the exterior surface of the transparent material and perpendicular to the reference axis shall occupy not less than 60 per cent of the smallest quadrilateral circumscribing the said projection, or the distance between two adjacent/tangential distinct parts shall not exceed 15 mm when measured perpendicularly to the reference axis.
- 3-2.5.4.2 The colours of the lights: red.
- 3-2.5.4.3 Position: in height: not less than 250 mm nor more than 1,500 mm above the ground; In the case of L2 and L5 category vehicles, if there is only one stop lamp its centre of reference must lie within the median longitudinal plane of the vehicle, or if there are two stop lamps they must be symmetrical to the median longitudinal plane of the vehicle. In the case of vehicles with two rear wheels: at least 400 mm between the two lamps.
- 3-2.5.4.4 Geometric visibility:
  - 3-2.5.4.4.1 Horizontal angle: 45 degrees to left and to right for a single lamp; 45 degrees outwards and 10 degrees inwards for each pair of lamps;
  - 3-2.5.4.4.2 Vertical angle: 15 degrees above and below the horizontal. The vertical angle below the horizontal may be reduced to 5 degrees , however, if the height of the lamp is less than 750 mm.
- 3-2.5.4.5 Orientation: Towards the rear of the vehicle.
- 3-2.5.4.6 Electrical connections: Shall light up at any service brake application.
- 3-2.5.5 Direction-indicator lamp: Mandatory on L2 with closed bodywork , L3 and L5. Optional on L1 and L2 without closed bodywork.
- 3-2.5.5.1 Number and arrangement: Two front indicators (category 1 or category 11 shall conform to requirements concerning "Direction-indicator lamp" regulated in "Standards"); Two rear indicators (category 2 or category 12 conform to requirements concerning "Direction-indicator lamp" regulated in VSTD).
- 3-2.5.5.2 The colours of the lights: orange (amber).
- 3-2.5.5.3 Position:
  - 3-2.5.5.3.1 In width:
    - 3-2.5.5.3.1.1 For front indicators, there shall be a minimum distance of 240 mm between illuminating surfaces,
    - 3-2.5.5.3.1.2 For front indicators, the indicators shall be situated outside the longitudinal vertical plane tangential to the outer edges of the illuminating surface of the headlamp(s),
    - 3-2.5.5.3.1.3 For front indicators, there shall be a minimum distance between the illuminating surface of the indicators and passing beam headlamp closest to one another as follows:

|                                     |                            |
|-------------------------------------|----------------------------|
| Minimum Indicator<br>intensity (cd) | Minimum<br>Separation (mm) |
|-------------------------------------|----------------------------|

The official directions are written in Chinese, this English edition is for your reference only.



|     |     |
|-----|-----|
| 90  | 75  |
| 175 | 40  |
| 250 | 20  |
| 400 | □20 |

- 3-2.5.5.3.1.4 For rear indicators, the clearance between the inner edges of the two illuminating surfaces shall be at least 180 mm; in case of vehicles of L1 category symbol, the clearance between the inner edges of the two apparent surfaces shall be at least 160mm.
- 3-2.5.5.3.1.5 Category symbols L2 and L5: the edges of the illuminating surface furthest from the median longitudinal plane must also not be more than 400 mm from the outermost part of the vehicle, the internal edges of the illuminating surfaces must be at a distance of at least 500 mm,
- 3-2.5.5.3.2 In height: not less than 350 mm nor more than 1,200 mm above the ground; In the case of L2 and L5 category vehicles, minimum 350 mm, maximum 1,500 mm above the ground.
- 3-2.5.5.3.3 In length: the forward distance between the centre reference of the rear indicators and the transverse plane which constitutes the rearmost limit of the vehicle's over-all length shall not exceed 300 mm.
- 3-2.5.5.4 Geometric visibility:
  - 3-2.5.5.4.1 Horizontal angle: 20 degrees inwards and 80 degrees outwards.
  - 3-2.5.5.4.2 Vertical angle: 15 degrees above and below the horizontal. The vertical angle below the horizontal may be reduced to 5 degrees, however, if the height of the lamp is less than 750mm.
- 3-2.5.5.5 Orientation: The front direction-indicators may move in line with the steering angle. May not be "combined" with any other lamp. May not be "reciprocally incorporated" with any other lamp.
- 3-2.5.5.6 Electrical connections: Direction-indicator lamps shall switch on independently of the other lamps. All direction-indicator lamps on one side of a vehicle shall be switched on and off by means of one control.
- 3-2.5.5.7 The light flashing frequency shall be 90 +/- 30 times per minute; operation of the light-signal control shall be followed within not more than one second by the appearance of the light and within not more than one-and-one half seconds by the first extinction of the light.
- 3-2.5.5.8 Tell-Tale: Mandatory. This may be optical or auditory or both. If it is optical it shall be (a) flashing green lamp(s), which, in the event of defective operation of any of the direction indicators, is extinguished, remains alight without flashing, or shows a marked change of frequency.
- 3-2.5.6 Rear-Registration-Plate illuminating device:
  - 3-2.5.6.1 The colours of the lights: white.
  - 3-2.5.6.2 Number: One. The device may consist of several optical components designed to illuminate the space reserved for the registration plate.
  - 3-2.5.6.3 Position: Such that the device illuminates the space reserved for the registration plate.
- 3-2.5.7 Front position lamp: Mandatory on L2, L3 and L5. Optional on L1
  - 3-2.5.7.1 Number: One or two, and the front position lamp shall conform to requirements concerning "Front position lamp" regulated in VSTD.

The official directions are written in Chinese, this English edition is for your reference only.

- 3-2.5.7.2 The colours of the lights: white.
- 3-2.5.7.3 Position: in length: at the front of the vehicle.
  - 3-2.5.7.3.1 In width:
    - 3-2.5.7.3.1.1 an independent front position lamp may be fitted above or below, or to one side of another front lamp: if these lamps are one above the other, the reference centre of the front position lamp must be located within the median longitudinal plane of the vehicle; if these lamps are side by side, their reference centres must be symmetrical in relation to the median longitudinal plane of the vehicle;
    - 3-2.5.7.3.1.2 a front position lamp, that is reciprocally incorporated with another front lamp, must be installed in such a way that its reference centre is situated in the median longitudinal plane of the vehicle. However, when the vehicle is also fitted with another front lamp alongside the front position lamp, their reference centres must be symmetrical in relation to the median longitudinal plane of the vehicle.
    - 3-2.5.7.3.1.3 Two front position lamps, one or both of them reciprocally incorporated with another front lamp, must be installed in such a way that their reference centres are symmetrical in relation to the median longitudinal plane of the vehicle.
    - 3-2.5.7.3.1.4 In the case of a L2 and L5 category vehicles with two front position lamps: the edges of the illuminating surface furthest from the median longitudinal plane of the vehicle must not be more than 400 mm from the outermost part of the vehicle, the internal edges of the illuminating surfaces must be at least 400 mm apart.
  - 3-2.5.7.3.2 In height: in height: not less than 350 mm nor more than 1,200 mm above the ground.
- 3-2.5.7.4 Geometric visibility:
  - 3-2.5.7.4.1 Horizontal angle: 80 degrees to left and to right for a single lamp: the horizontal angle may be 80 degrees outwards and 45 degrees inwards for each pair of lamps.
  - 3-2.5.7.4.2 Vertical angle: 15 degrees above and below the horizontal. The vertical angle below the horizontal may be reduced to 5 degrees , however, if the height of the lamp is less than 750 mm.
- 3-2.5.7.5 Orientation: Forwards. The lamp(s) may move in line with the steering angle.
- 3-2.5.7.6 "Circuit-closed" tell-tale: Mandatory. Non-flashing green signal lamp. This tell-tale shall not be required if the instrument illumination lighting can be switched on or off only simultaneously with the position lamp(s).
- 3-2.5.8 Rear retro-reflector, non-triangular:
  - 3-2.5.8.1 Number: One or two, however, in the case of L2 and L5 category vehicles with a maximum width exceeding 1,000 mm, two non-triangular rear reflectors are required. The performances of which shall conform to the requirements of "Retro-reflector" concerning Class IA or IB retro-reflectors regulated in VSTD. In the case of a L2 and L5 category vehicles with two rear retro-reflectors: the point of the illuminating surface furthest from the median longitudinal plane of the vehicle must not be more than 400 mm from the outermost part of the vehicle, the internal edges of the retro-reflectors must be at least 400 mm apart.
  - 3-2.5.8.2 The colours of the lights: red.
  - 3-2.5.8.3 Position: in height: not less than 250 mm nor more than 900 mm above the ground;
  - 3-2.5.8.4 Geometric visibility:
    - 3-2.5.8.4.1 Horizontal angle: 30 degrees to left and to right for a single reflector; 30 degrees outwards and 10 degrees inwards

The official directions are written in Chinese, this English edition is for your reference only.

- for each pair of reflectors;
  - 3-2.5.8.4.2 Vertical angle: 15 degrees above and below the horizontal. The vertical angle below the horizontal may be reduced to 5 degrees , however, if the height of the lamp is less than 750 mm.
  - 3-2.5.8.5 Orientation: Rearwards.
- 3-2.5.9 Side retro-reflector, non-triangular:
  - 3-2.5.9.1 Number: One or two, the performances of which shall conform to the requirements of “Retro-reflector” concerning Class IA or IB retro-reflectors regulated in VSTD.
  - 3-2.5.9.2 The colours of the lights: amber at the front, amber or red at the rear
  - 3-2.5.9.3 Position: on the side of the vehicle.
    - 3-2.5.9.3.1 In height: in case of vehicles of L1 category symbol, not less than 300mm or more than 1,000mm above the ground;
    - 3-2.5.9.3.2 In height: in case of L2, L3 and L5 category vehicles, not less than 300mm nor more than 900mm above the ground;;
    - 3-2.5.9.3.3 In length: should be placed in such a position that under normal conditions it may not be masked by the driver's or passenger's clothes.
  - 3-2.5.9.4 Geometric visibility:
    - 3-2.5.9.4.1 Horizontal angle: 30 degrees to the front and to the rear.
    - 3-2.5.9.4.2 Vertical angle: 15 degrees above and below the horizontal. The vertical angle below the horizontal may be reduced to 5 degrees , however, if the height of the retro-reflector is less than 750 mm.
  - 3-2.5.9.5 Orientation: The reference axis of the retro-reflectors must be perpendicular to the vehicle's median longitudinal plane and directed outwards. The front side retro-reflectors may move with the steering angle.
- 3-2.5.10 Pedal retro-reflectors: Mandatory on L1 and L2.
  - 3-2.5.10.1 Number: Four retro-reflectors or retro-reflector groups, the performances of which shall conform to the requirements of “Retro-reflector” concerning Class IA or IB retro-reflectors regulated in the VSTD.
  - 3-2.5.10.2 The colours of the lights: orange (amber).
  - 3-2.5.10.3 Other requirements:
    - 3-2.5.10.3.1 The outer faces of the illuminating surface of the retro-reflectors shall be recessed into the body of the pedal.
    - 3-2.5.10.3.2 The retro-reflectors shall be mounted in the pedal body in such a way as to be clearly visible both to the front and to the rear of the vehicle. The reference axis of such retro-reflectors, the shape of which shall be adapted to that of the pedal body, shall be perpendicular to the pedal axis.
    - 3-2.5.10.3.3 Pedal retro-reflectors shall be fitted only to those pedals of the vehicle which, by means of cranks or similar devices, can be used to provide a means of propulsion alternative to the engine.
- 3-2.6 The motor vehicle can install the auxiliary lamps and marks that can conform to the following regulations, under the consideration of driving safety or specific operations.
  - 3-2.6.1 Identification lamp for large vehicles:
    - 3-2.6.1.1 The colours of the lights: red, yellow or green at the front; red at the rear. The identification lamp that has no speed-indicating function at the vehicle’s front side shall not use green color.
    - 3-2.6.1.2 Number: three at the front and three at the rear. The one with the speed-indicating function shall orient forwards.
  - 3-2.6.2 Cornering lamp:

The official directions are written in Chinese, this English edition is for your reference only.

- 3-2.6.2.1 Number: Two.
- 3-2.6.2.2 The colours of the lights: white.
- 3-2.6.2.3 Position:
  - 3-2.6.2.3.1 In width: that point on the apparent surface in the direction of the reference axis which is farthest from the vehicle's median longitudinal plane shall not be more than 400 mm from the extreme outer edge of the vehicle.
  - 3-2.6.2.3.2 In height: minimum: Not less than 250 mm above the ground; maximum: Not more than 900 mm above the ground; However, no point on the apparent surface in the direction of the reference axis shall be higher than the highest point on the apparent surface in the direction of the reference axis of the dipped-beam headlamp.
  - 3-2.6.2.3.3 In length: not further than 1,000 mm from the front.
- 3-2.6.2.4 Geometric visibility:
  - 3-2.6.2.4.1 Horizontal angle: 30 degrees to 60 degrees outwards.
  - 3-2.6.2.4.2 Vertical angle: 10 degrees upwards and downwards.
- 3-2.6.2.5 Orientation: Such that the lamps meet the requirements for geometric visibility.
- 3-2.6.2.6 Electrical connections:

The cornering lamps must be so connected that they cannot be activated unless the mainbeam headlamps or the dipped-beam headlamps are switched ON at the same time.

  - 3-2.6.2.6.1 The cornering lamps must be so connected that they cannot be activated unless the mainbeam headlamps or the dipped-beam headlamps are switched ON at the same time. The cornering lamp on one side of the vehicle may only be switched ON automatically when the direction indicators on the same side of the vehicle are switched ON and/or when the steering angle is changed from the straight-ahead position towards the same side of the vehicle. The cornering lamp shall be switched OFF automatically when the direction indicator is switched OFF and/or the steering angle has returned in the straight-ahead position.
  - 3-2.6.2.6.2 When the reversing lamp is switched ON, both cornering lamps may be switched on simultaneously, independently from the steering wheel or direction indicator position. In this case, the cornering lamps shall be switched OFF when the reversing lamp is switched OFF.
- 3-2.6.2.7 The cornering lamps shall not be activated at vehicle speeds above 40 km/h.
- 3-2.6.3 Daytime running lamp:
  - 3-2.6.3.1 Number: Two.
  - 3-2.6.3.2 The colours of the lights: white.
  - 3-2.6.3.3 Position:
    - 3-2.6.3.3.1 In width: that point on the apparent surface in the direction of the reference axis which is farthest from the vehicle's median longitudinal plane shall not be more than 400 mm from the extreme outer edge of the vehicle. The distance between the inner edges of the apparent surfaces in the direction of the reference axes shall not be less than 600 mm. This distance may be reduced to 400 mm where the overall width of the vehicle is less than 1,300 mm.
    - 3-2.6.3.3.2 In height: above the ground not less than 250 mm nor more than 1,500 mm.
    - 3-2.6.3.3.3 In length: at the front of the vehicle. This requirement shall be deemed to be satisfied if the light emitted does not cause discomfort to the driver either directly, or indirectly through the rear-view mirrors and/or other reflecting

The official directions are written in Chinese, this English edition is for your reference only.

surfaces of the vehicle.

3-2.6.3.4 Geometric visibility:

3-2.6.3.4.1 Horizontal angle: outwards 20 degrees and inwards 20 degrees.

3-2.6.3.4.2 Vertical angle: upwards 10 degrees and downwards 10 degrees.

3-2.6.3.5 Orientation: Towards the front.

3-2.6.3.6 Electrical connections:

3-2.6.3.6.1 If installed, the daytime running lamps shall be switched ON automatically when the device which starts and/or stops the engine is in a position which makes it possible for the engine to operate. It shall be possible to activate and deactivate the automatic switching ON of daytime running lamps without the use of tools.

3-2.6.3.6.2 The daytime running lamp shall switch OFF automatically when the front fog lamps or headlamps are switched ON, except when the latter are used to give intermittent luminous warnings at short intervals.

3-2.6.3.6.3 The signal lamps such as front and rear position lamps and so on, are not switched ON when the daytime running lamps are switched ON.

3-2.6.4 Working/cargo lamp, spot lamp:

3-2.6.4.1 The colours of the lights: white or light yellow. It's installed in correspondence to the actual demand.(It's not apply to passenger vehicle and motorcycle.)

3-2.6.4.2 The lamp's switch shall not interact with other lamps.

3-2.6.4.3 If the lamp will affect the driver's visual sight of other motor vehicles passing by, then a fixed shielding device shall be required.

3-2.6.5 Front fog lamp for motor vehicles:

3-2.6.5.1 Number: Two, the performances of which shall conform to the requirements concerning "Front fog lamp" regulated in "Standards".

3-2.6.5.2 The colours of the light emitted by the lamps: white or selective yellow

3-2.6.5.3 Position:

3-2.6.5.3.1 In width: that point on the apparent surface in the direction of the reference axis which is farthest from the vehicle's median longitudinal plane shall not be more than 400 mm from the extreme outer edge of the vehicle.

3-2.6.5.3.2 In height: Minimum: Not less than 250 mm above the ground. Maximum: For M1 and N1 category vehicles: not more than 800 mm above the ground. For all other categories except N3G (off-road) vehicles: not more than 1,200 mm above the ground. For category N3G vehicles: the maximum height may be increased to 1,500 mm. no point on the apparent surface in the direction of the reference axis must be higher than the highest point on the apparent surface in the direction of the reference axis of the dipped-beam headlamp.

3-2.6.5.3.3 In length: at the front of the vehicle. This requirement shall be deemed to be satisfied if the light emitted does not cause discomfort to the driver either directly, or indirectly through the rear-view mirrors and/or other reflecting surfaces of the vehicle.

3-2.6.5.4 Geometric visibility:

3-2.6.5.4.1 Horizontal angle: 45 degrees outwards and 10 degrees inwards.

3-2.6.5.4.2 Vertical angle: 5 degrees upwards and downwards.

The official directions are written in Chinese, this English edition is for your reference only.

- 3-2.6.5.4.3 Since the photometric values required for front fog lamps do not cover the full geometric field of vision, a minimum value of one cd in the space remaining is required for type-approval purposes. The presence of partitions or other items of equipment near the front fog lamp shall not give rise to secondary effects causing discomfort to other road users.
- 3-2.6.5.5 Orientation: Towards the front.
- 3-2.6.5.5.1 Vertical orientation.
- 3-2.6.5.5.1.1 In the case of class "B" front fog lamps the vertical inclination of the cut-off to be set in the unladen vehicle state with one person in the driver's seat shall be -1.5 per cent or lower.
- 3-2.6.5.5.1.2 In the case of class "F3" front fog lamps:
- 3-2.6.5.5.1.2.1 the initial downward inclination of the cut-off to be set in the unladen vehicle state with one person in the driver's seat shall be specified within an accuracy of one decimal place by the manufacturer and indicated in a clearly legible and indelible manner on each vehicle close to either the front fog lamp or the manufacturer's plate or in combination with the indication by the symbol.
- 3-2.6.5.5.1.2.2 depending on the mounting height in metre (h) of the lower edge of the apparent surface in the direction of the reference axis of the front fog lamp, measured on the unladen vehicles, the vertical inclination of the cut-off to be set in the unladen vehicle state with one person in the driver's seat shall have the following value(s):
- h < 0.8  
Limits: between -1.0 per cent and -2.5 per cent  
Initial aiming: between -1.5 per cent and -2.0 per cent
- h > 0.8  
Limits: between -1.5 per cent and -3.0 per cent  
Initial aiming: between -2.0 per cent and -2.5 per cent
- 3-2.6.5.5.1.3 Front fog lamp leveling device
- 3-2.6.5.5.1.3.1 In the case of a front fog lamp with (a) light source(s) having a total objective luminous flux, which exceeds 2,000 lumen, the requirements of paragraph 3-2.6.5.5.1.2.2 shall be automatically satisfied under all the loading conditions.
- 3-2.6.5.5.1.3.2 Where a leveling device is fitted for a front fog lamp, independent or grouped with other front lighting and light signaling functions, it shall be such that the vertical inclination, under all the static loading conditions, shall remain between the limits prescribed in paragraph 3-2.6.5.5.1.2.2
- 3-2.6.5.5.1.3.3 In the case where the front fog lamp of category "F3" is part of the dipped beam headlamp or is part of an AFS system, the requirements of paragraph 3-2.6.5.5. shall be applied during the use of the front fog beam as part of the dipped beam.  
In this case the leveling limits defined in paragraph 3-2.6.5.5. may be applied also when this front fog lamp is used as such.
- 3-2.6.5.5.1.3.4 The leveling device may also be used to automatically adapt the inclination of the front fog beam in relation to the prevailing ambient conditions, provided that the limits for the downward inclination specified in



- paragraph 3-2.6.5.5.1.2.2. are not exceeded.
- 3-2.6.5.5.1.3.5 In the case of a failure of the leveling device, the front fog beam shall not assume a position in which the cut off is less inclined than it was at the time when the failure of the device occurred.
- 3-2.6.5.5.2 Vertical orientation: When a beam from a front fog lamp is activated as part of a dipped beam provided by an AFS, it has to comply with the requirements of paragraph 3-2.6.16.6.1 of this Regulation.
- 3-2.6.5.6 Electrical connections: It must be possible to switch the front fog lamps ON and OFF independently of the main-beam headlamps, the dipped-beam headlamps or any combination of main- and dipped-beam headlamps, unless the front fog lamps are used as part of another lighting function in an AFS. However, the switching ON of the front fog lamps function shall have the priority over the function for which the front fog lamps are used as a part.
- 3-2.6.5.7 Tell-tale: Circuit-closed tell-tale mandatory. An independent non-flashing warning light.
- 3-2.6.5.8 Other requirements:
- 3-2.6.5.8.1 In the case where there is a positive indication in the communication the alignment and the luminous intensities of the class "F3" front fog beam may be automatically adapted in relation to the prevailing ambient conditions. Any variations of the luminous intensities or alignment shall be performed automatically and in such a way that no discomfort, neither for the driver nor to other road users, is caused.
- 3-2.6.5.8.2 The front fog lamps may substitute the function of the front position lamps, provided that:
- 3-2.6.5.8.2.1 Their electrical connections are such that in case of failure of any of these lighting devices the front position lamps are automatically re-activated; and
- 3-2.6.5.8.2.2 The substituting lamp/function meets, for the respective position lamp, the requirements concerning:
- (1) The geometric visibility prescribed for the front position lamps in 3-2.4.3.4; and
- (2) The minimum photometric values according to the angles of light distribution; and
- 3-2.6.5.8.2.3 Appropriate evidence demonstrating compliance with the requirements indicated in paragraph 3-2.6.5.8.2.2. above is provided in the test reports of the substituting lamp.
- 3-2.6.6 Parking lamp: On motor vehicles not exceeding 6 m in length and not exceeding 2 m in width, optional. On all other vehicles, prohibited.
- 3-2.6.6.1 Number and arrangement: Either two lamps at the front and two lamps at the rear, or one lamp on each side, the performances of which shall conform to the requirements concerning "Parking lamp" or "clearance /front (side) position lamp" / "tail/ rear (side) position lamp" regulated in VSTD.
- 3-2.6.6.2 The colour of the light emitted by the lamps: white in front, red at the rear, amber if reciprocally incorporated in the side direction-indicator lamps or in the side-marker lamps.
- 3-2.6.6.3 Position:
- 3-2.6.6.3.1 In width: that point on the apparent surface in the direction of the reference axis which is farthest from the vehicle's median longitudinal plane shall not be more than 400 mm from the extreme outer edge of the vehicle. Furthermore, if there are two lamps, they shall be on the sides of the vehicle.
- 3-2.6.6.3.2 In height: For M1 and N1 category vehicles: no special requirement; For all other categories of vehicles: above the ground, not less than 350 mm nor more than 1,500 mm (2,100 mm if the shape of the bodywork makes it impossible to keep within 1,500 mm).



- 3-2.6.6.4 Geometric visibility:
  - 3-2.6.6.4.1 Horizontal angle: 45 degrees outwards, forwards and rearwards.
  - 3-2.6.6.4.2 Vertical angle: 15 degrees above and below the horizontal. The vertical angle below the horizontal may be reduced to 5 degrees, however, if the height of the lamp is less than 750 mm.
- 3-2.6.6.5 Electrical connections: The connection must allow the parking lamp(s) on the same side of the vehicle to be lit independently of any other lamps. The parking lamp(s) and, if applicable, the front and rear position lamps on the same side which can be switched on according to paragraph 3-2.6.6.7 shall still be able to be activated even if the engine power switch is on the "off" position. A device which automatically deactivates these lamps using timer switch is prohibited.
- 3-2.6.6.6 Tell-tale: Circuit-closed tell-tale optional. If there is one, it must not be possible to confuse it with the tell-tale for the front and rear position lamps.
- 3-2.6.6.7 Other requirements: The functioning of this lamp may also be performed by simultaneously switching on the front and rear position lamps on the same side of the vehicle. In this case, lamps that meet the requirements of front or rear (side) position lamps are deemed to meet the requirements of parking lamps. In this case, lamps that meet the requirements of front or rear (side) position lamps are deemed to meet the requirements of parking lamps.
- 3-2.6.7 Front fog lamp for motorcycle: Optional on vehicles of category symbol L3 and L5.
  - 3-2.6.7.1 Number: One or two, the performances of which shall conform to the requirements concerning "Front fog lamp" regulated in VSTD.
  - 3-2.6.7.2 The colour of the light: white or selective yellow.
  - 3-2.6.7.3 The installing location:
    - 3-2.6.7.3.1 In width: for a single lamp the centre of reference shall be in the median longitudinal plane of the vehicle; or the edge of the illuminating surface which is nearest to that plane shall be not more than 250 mm away from it; In the case of L5 category vehicles, the edges of the illuminating surfaces furthest from the median longitudinal plane of the vehicle must not be more than 400 mm from the outermost edge of the vehicle.
    - 3-2.6.7.3.2 In height: not less than 250 mm above the ground. No point on the illuminating surface shall be higher than the highest point on the illuminating surface of the passing beam headlamp.
    - 3-2.6.7.3.3 In length: at the front of the vehicle. This requirement shall be deemed to be satisfied if the light emitted does not cause discomfort to the driver either directly, or indirectly through the rear-view mirrors and/or other reflecting surfaces of the vehicle.
  - 3-2.6.7.4 Geometric visibility:
    - 3-2.6.7.4.1 Horizontal angle: 45 degrees to left and to right for a single lamp, except for an off-centre light, in which case the inward angle 10 degrees ; 45 degrees outwards and 10 degrees inwards for each pair of lamps
    - 3-2.6.7.4.2 Vertical angle: 5 degrees upwards and downwards;
  - 3-2.6.7.5 Orientation: Forwards. The lamp(s) may move in line with the steering angle.
  - 3-2.6.7.6 May not be combined with any other front lamp.
  - 3-2.6.7.7 Tell-tale: "Circuit-closed" tell-tale. Optional; non-flashing green signal.
  - 3-2.6.7.8 Electrical connections: It shall be possible to switch the fog lamp(s) on or off independently of the driving beam headlamp(s) and/or passing beam headlamp(s).

The official directions are written in Chinese, this English edition is for your reference only.

- 3-2.6.8 Rear fog lamp for motorcycle: Optional on vehicles of category symbol L3 and L5.
  - 3-2.6.8.1 Number: One or two.
  - 3-2.6.8.2 The colour of the light: red.
  - 3-2.6.8.3 Position:
    - 3-2.6.8.3.1 In height: not less than 250 mm nor more than 900 mm above the ground; In the case of L5 category vehicles, minimum 250 mm, maximum 1000 mm above the ground.
    - 3-2.6.8.3.2 In length: at the rear of the vehicle. The distance between the illuminating surface of the rear fog lamp and that of the stop lamp shall not be less than 100 mm.
    - 3-2.6.8.3.3 Width: the reference centre must be situated in the median longitudinal plane of the L5 category vehicle if there is a single rear fog lamp or, if there are two fog lamps, they must be symmetrical in relation to the median longitudinal plane of the vehicle. In the case of vehicles with two rear wheels: at least 400 mm between the two lamps.
  - 3-2.6.8.4 Geometric visibility:
    - 3-2.6.8.4.1 Horizontal angle: 25 degrees to left and to right for a single lamp; 25 degrees outwards and 10 degrees inwards for each pair of lamps;
    - 3-2.6.8.4.2 Vertical angle: 5 degrees upwards and downwards.
  - 3-2.6.8.5 Orientation: Rearwards.
  - 3-2.6.8.6 Electrical connections: They shall be such that the rear fog lamp can light up only when one or more of the following lamps are switched on: driving beam headlamp, passing beam headlamp, front fog lamp. If there is a front fog lamp, it shall be possible to switch off the rear fog lamp independently of the front fog lamp. The rear fog lamp(s) may continue to operate until the position lamps are switched off and they shall remain off until deliberately switched on again.
  - 3-2.6.8.7 Tell-tale: "Circuit-closed" tell-tale. Mandatory. Non-flashing amber signal lamp.
- 3-2.6.9 Front retro-reflector, non-triangular: Optional on vehicles of category symbol L3.
  - 3-2.6.9.1 Number: One, the performances of which shall conform to the requirements of "Retro-reflector" concerning Class IA or IB retro-reflectors regulated in VSTD.
  - 3-2.6.9.2 The colour of the light: white.
  - 3-2.6.9.3 Position: in height: not less than 400mm nor more than 1,200mm above the ground;
  - 3-2.6.9.4 Geometric visibility:
    - 3-2.6.9.4.1 Horizontal angle: 30 degrees to the left and to the right.
    - 3-2.6.9.4.2 Vertical angle: 15 degrees above and below the horizontal. The vertical angle below the horizontal may be reduced to 5 degrees, however, if the height of the reflector is less than 750mm.
  - 3-2.6.9.5 Orientation: Forwards. The reflector may move in line with the steering angle.
- 3-2.6.10 Auxiliary stop lamp for motorcycle:
  - 3-2.6.10.1 The colour of the light: red.
  - 3-2.6.10.2 Its reference centre lies within the median longitudinal plane of the vehicle and above other rear lamps.
  - 3-2.6.10.3 The light emitted shall be Non-flashing.
- 3-2.6.11 Hazard warning signal for motorcycle: Optional on vehicles of category symbol L3 and L5. The signal shall be given by means of a separate control enabling all the direction indicators to be supplied with current simultaneously. The other aspects are identical to

The official directions are written in Chinese, this English edition is for your reference only.

- the regulations specified in the direction-indicator lamp section.
- 3-2.6.12 Daytime running lamp:
- 3-2.6.12.1 Number: One, or two symmetrically.
  - 3-2.6.12.2 The colour of the light: white or light yellow. For the two-lamp case the two lamps' color should be identical.
  - 3-2.6.12.3 Position: The height of illuminating surface above ground shall be within 0.5 to 1.2m.
- 3-2.6.13 Parking lamp for motorcycle:
- 3-2.6.13.1 While stationary, the light emitted shall be non- flashing.
  - 3-2.6.13.2 The colour of the light: white or light yellow at the front, and red at the rear.
- 3-2.6.14 Retro-reflective markings for heavy and long vehicles and their trailers: Vehicles of category symbols M2, M3, N and O, the performances of which shall conform to the requirements concerning retro-reflective marking regulated in VSTD.
- 3-2.6.14.1 It may consist of marking materials of class "D" if the total retro-reflective area is less than 2m<sup>2</sup>; if the total retro-reflective area is at least 2m<sup>2</sup> class "E" shall be used.
  - 3-2.6.14.2 The width of a side and/or rear marking material shall be 50 mm +10/-0 mm. The markings shall be made of strips of retro-reflective material.
  - 3-2.6.14.3 Guidelines for the marking shape and mounting requirements:
    - 3-2.6.14.3.1 Side and rear marking with strips:
      - 3-2.6.14.3.1.1 Retro-reflective marking materials installed on vehicles may be made up of an element or several elements preferably continuously, parallel or as close as possible parallel to the ground. The same rule applies for tractors, semi-trailers and other vehicle combinations.
      - 3-2.6.14.3.1.2 Those installed on the rear of vehicles may be red or yellow in colour.
      - 3-2.6.14.3.1.3 Those installed on the sides of vehicles shall be white or yellow in colour.
      - 3-2.6.14.3.1.4 The mounting of the markings should identify as close as possible the entire length and width of the vehicle. "Entire" means at least 80 % of the length and/or width.
      - 3-2.6.14.3.1.5 In case of non-continuous strips the distance between single elements should be as small as possible and should not exceed 50 % of the shortest element length.
- However, if the manufacturer can prove to the satisfaction of the authority responsible for type approval that it is impossible to respect the value of 50 per cent, the distance between adjacent elements may be larger than 50 per cent of the shortest adjacent element, and it shall be as small as possible and not exceed 1000 mm.
- 3-2.6.14.3.1.6 Retro-reflective marking materials shall have a minimum height above the ground of at least 250 mm and a maximum height of 1,500 mm. However, 2,100 mm may be accepted in cases where technical conditions forbid the compliance with the maximum value of 1,500 mm.
  - 3-2.6.14.3.1.7 The distance between the retro-reflective marking materials fitted to the rear of a vehicle and each obligatory stop lamp should be greater than 200mm.
- 3-2.6.14.3.2 Contour marking:
- 3-2.6.14.3.2.1 The mounting of the contour markings should identify as close as possible the overall shape of the vehicle to the side and rear.
  - 3-2.6.14.3.2.2 Contour markings installed on the rear of vehicles may be red in colour.

3-2.6.14.3.2.3 Contour markings installed on the sides of vehicles shall be white or yellow in colour.

3-2.6.14.3.2.4 In case of non-continuous strips, the distance between single elements should be as small as possible and should not exceed 50 % of the shortest element length.

However, if the manufacturer can prove to the satisfaction of the authority responsible for type approval that it is impossible to respect the value of 50 per cent, the distance between adjacent elements may be larger than 50 per cent of the shortest adjacent element, and it shall be as small as possible and not exceed 1000 mm.

3-2.6.14.3.2.5 The lower part of the retro-reflective marking materials should have a minimum height above the ground of at least 250 mm and a maximum height of 1,500 mm.

3-2.6.14.3.2.6 The distance between the retro-reflective marking materials fitted to the rear of a vehicle and each obligatory stop lamp should be greater than 200mm.

3-2.6.14.3.3 Distinctive markings and graphics:

Retro-reflective distinctive markings and/or graphics should only be placed within the contour marking on the side of a vehicle, provided they do not impair the effectiveness of the contour marking and the mandatory lighting and light-signaling devices. Compared to the contour marking, the distinctive markings and/or graphics should be decent as specified below:

3-2.6.14.3.3.1 The number of the letters/characters is less than 15;

3-2.6.14.3.3.2 The height of the letters/characters is between 300 mm and 1,000 mm;

3-2.6.14.3.3.3 The whole retro-reflective area is not larger than 2.0 m<sup>2</sup>.

3-2.6.14.4 Examples of retro-reflective markings:

3-2.6.14.4.1 Examples of retro-reflective markings with strips

Example A

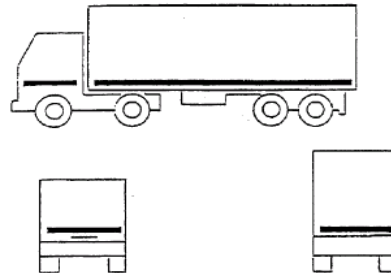

Example B

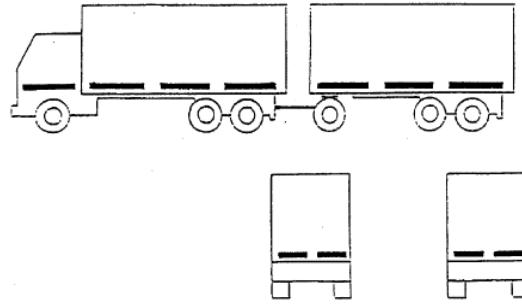

Example C

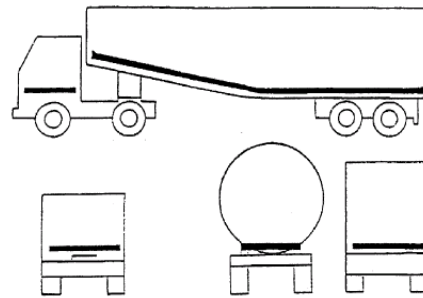

Example D

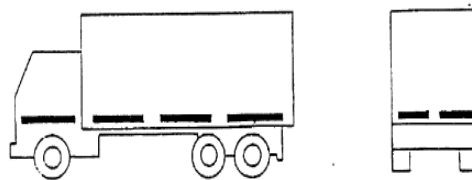

Example E

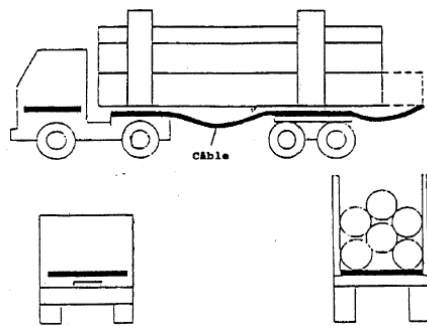

3-2.6.14.4.2 Examples of retro-reflective contour markings (with distinctive markings and graphics)

Example A

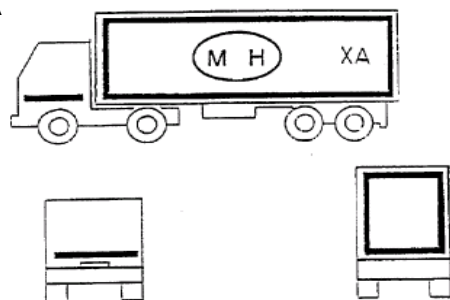

Example B

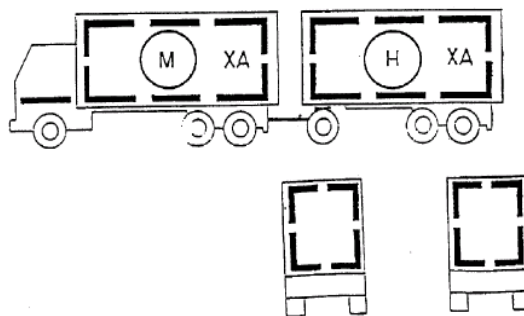



Example C

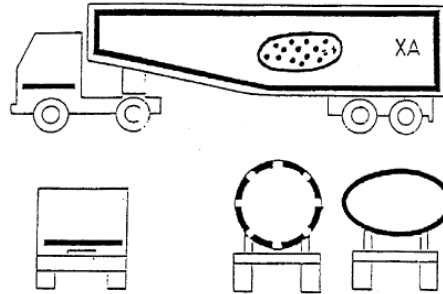

Example D

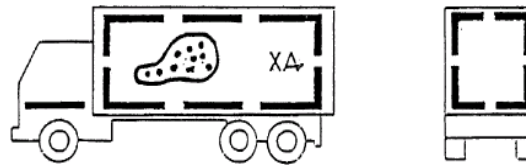

3-2.6.15 Side direction-indicator lamps : The category of O2, O3 and O4 vehicles could add two or four lamps for conform to side direction-indicator lamps (categories 5 or 6) stipulate in “Direction indicator” regulated in VSTD.

3-2.6.16 ADAPTIVE FRONT LIGHTING SYSTEM (AFS)

Where not otherwise specified below, the requirements for main-beam headlamps and for dipped-beam headlamps of this Regulation apply to the relevant part of the AFS.

3-2.6.16.1 Presence

Optional on motor vehicles. Prohibited on trailers.

3-2.6.16.2 Number

One

3-2.6.16.3 Arrangement

No special requirements.

The official directions are written in Chinese, this English edition is for your reference only.

#### 3-2.6.16.4 Position

The AFS shall, prior to the subsequent test procedures, be set to the neutral state;

##### 3-2.6.16.4.1 In width and height:

for a given lighting function or mode the requirements indicated in the paragraphs 3-2.6.16.4.1.1 through 3-2.6.16.4.1.4 below shall be fulfilled by those lighting units which are energized simultaneously for that lighting function or mode of a function, according to the applicant's description. All dimensions refer to the nearest edge of the apparent surface(s) observed in the direction of the reference axis, of the lighting unit(s).

3-2.6.16.4.1.1 Two lighting units shall be positioned symmetrically at a height in compliance with the requirements of the relevant paragraphs 3-2.4.1 and 3-2.4.2.(where "Two symmetrically placed lighting units" shall be understood to be two lighting units, one on each side of the vehicle, positioned such that the (geometric) centres of gravity of their apparent surfaces are at the same height and at the same distance from the vehicle's longitudinal median plane within a tolerance of 50 mm, each; their light emitting surfaces, illuminating surfaces, and light outputs, however, may differ.)

3-2.6.16.4.1.2 Additional lighting units, if any, on either side of the vehicle shall be positioned at a distance not exceeding 140 mm in horizontal direction (E in the figure) and 400 mm in vertical direction above or below (D in the figure) from the nearest lighting unit;

3-2.6.16.4.1.3 None of the additional lighting units described in paragraph 3-2.6.16.4.1.2 above shall be positioned lower than 250 mm (F in the figure) nor higher than indicated in paragraph 3-2.4.2.3.2 of this Regulation (G in the figure) above the ground;

3-2.6.16.4.1.4 Additionally, in width: for each mode of the passing beam lighting: the outer edge of the apparent surface of at least one lighting unit on each side of the vehicle shall not be more than 400 mm from the extreme outer edge of the vehicle (A in the figure); and, the inner edges of the apparent surfaces in the direction of the reference axes shall be not less than 600 mm apart. This does not apply, however, for M1 and N1 category vehicles; for all other categories of motor vehicles this distance may be reduced to 400 mm where the overall width of the vehicle is less than 1300 mm.

##### 3-2.6.16.4.2 In length:

all lighting units of an AFS shall be mounted at the front. This requirement is deemed to be satisfied if the light emitted does not cause discomfort to the driver either directly, or indirectly through the rear-view mirrors and/or other reflecting surfaces of the vehicle.

##### 3-2.6.16.5 Geometric visibility:

On each side of the vehicle, for each lighting function and mode provided: the angles of geometric visibility prescribed for the respective lighting functions according to paragraphs 3-2.4.1.5 and 3-2.4.2.4 of this Regulation, shall be met by at least one of the lighting units that are simultaneously energized to perform said function and mode(s), according to the description of the applicant. Individual lighting units may be used to comply with the requirements for different angles.

##### 3-2.6.16.6 Orientation: Towards the front.

The AFS shall, prior to the subsequent test procedures, be set to the neutral state, emitting the basic passing beam.

3-2.6.16.6.1 Vertical orientation:

3-2.6.16.6.1.1 The initial downward inclination of the cut-off of the basic passing beam to be set in the unladen vehicle state with one person in the driver's seat shall be specified with a precision of 0.1 per cent by the manufacturer and indicated in clearly legible and indelible manner on each vehicle, close to either the front lighting system or the manufacturer's plate.

Where differing initial downward inclinations are specified by the manufacturer for different lighting units that provide or contribute to the cut-off of the basic passing beam, these values of downward inclination shall be specified with a precision of 0.1 per cent by the manufacturer and indicated in clearly legible and indelible manner on each vehicle, close to either the relevant lighting units or on the manufacturer's plate, in such a way that all the lighting units concerned can be unambiguously identified.

3-2.6.16.6.1.2 The horizontal part of the "cut-off" of the basic passing beam shall remain between the limits indicated in paragraph 3-2.4.2.5.1.2 of this Regulation under all the static loading conditions of the vehicle of Annex 5 of this Regulation; and the initial aiming shall be within the specified values.

3-2.6.16.6.1.2.1 in case the passing beam is generated by several beams from different lighting units, the provisions according to paragraph 3-2.6.16.6.1.2 above apply to each said beam's "cut-off" (if any).

3-2.6.16.6.2 Headlamp levelling device: In the case where a vertical inclination adjusting device is necessary to satisfy the requirements of paragraph 3-2.4.2.5.1 the device shall be automatic headlamp levelling device. In the event of a failure of this device, the passing beam shall not assume a position in which the dip is less than it was at the time when the failure of the device occurred.

3-2.6.16.6.3 Horizontal orientation:

For each lighting unit the kink of the elbow of the cut-off line, if any, when projected on the screen, shall coincide with the vertical line through the reference axis of said lighting unit. A tolerance of 0.5 degrees to that side which is the side of the traffic direction shall be allowed. Other lighting units shall be adjusted according to the applicant's specification.

3-2.6.16.6.4 Measuring procedure:

After adjustment of the initial setting of beam orientation, the vertical inclination of the passing beam or, when applicable, the vertical inclinations of all the different lighting units that provide or contribute to the cut-off(s) according to paragraph 3-2.6.16.6.1.2.1 above of the basic passing beam, shall be verified for all loading conditions of the vehicle in accordance with the specifications in paragraphs 3-2.4.2.5.1.2 of this Regulation.

3-2.6.16.7 Electrical connections

3-2.6.16.7.1 Main beam lighting (if provided by the AFS)

(a) The lighting units for the main-beam may be activated either simultaneously or in pairs. For changing over from the dipped-beam to the main-beam at least one pair of lighting units for the main-beam shall be activated. For changing over from the main-beam to the dipped-beam all lighting units for the main-beam shall be de-activated simultaneously.

(b) The dipped-beams may remain switched on at the same time as the main-beams.

(c) Where four concealable lighting units are fitted their raised position must prevent the simultaneous operation of

any additional headlamps fitted, if these are intended to provide light signals consisting of intermittent illumination at short intervals (see paragraph 3-2.4.1.2) in daylight.

3-2.6.16.7.2

Passing beam lighting

(a) The control for changing over to the dipped-beam must switch off all main-beam headlamps or de-activate all AFS lighting units for the main-beam simultaneously.

(b) The dipped-beam may remain switched on at the same time as the main-beams.

(c) In the case of lighting units for the dipped-beam being equipped with gas discharge light sources, the gas-discharge light sources shall remain switched on during the main-beam operation.

3-2.6.16.7.3

Switching ON and OFF the passing beam may be automatic, however, the electrical connections must be such that the front and rear position lamps, the endoutline marker lamps, if they exist, the side-marker lamps, if they exist, and the rear registration plate lamp can only be switched on and off simultaneously.

3-2.6.16.7.4

Automatic operation of the AFS

The changes within and between the provided classes and their modes of the AFS lighting functions as specified below, shall be performed automatically and such that no discomfort, neither for the driver nor for other road users, is caused.

The following conditions apply for the activation of the classes and their modes of the passing beam and, where applicable, of the main-beam.

3-2.6.16.7.4.1 The class C mode(s) of the passing beam shall be activated if no mode of another passing beam class is activated.

3-2.6.16.7.4.2 The class V mode(s) of the passing beam shall not operate unless one or more of the following conditions is/are automatically detected (V-signal applies):

(a) roads in built-up areas and the vehicle's speed not exceeding 60 km/h;

(b) roads equipped with a fixed road illumination, and the vehicle's speed not exceeding 60 km/h;

(c) a road surface luminance of 1 cd/m<sup>2</sup> and/or a horizontal road illumination of 10 lx being exceeded

continuously;

(d) the vehicle's speed not exceeding 50 km/h.

3-2.6.16.7.4.3 The class E mode(s) of the passing beam shall not operate unless the vehicle's speed exceeds 70 km/h and one or more of the following conditions is/are automatically detected.

(a) The road characteristics correspond to motorway conditions 8/ and/or the vehicle's speed exceeds 110 km/h (E-signal applies).

(b) In case of a class E mode of the passing beam which, according to the system's approval documents /communication sheet, complies with a 'data set' of Table 6 only.

Data set E1: the vehicle's speed exceeds 100 km/h (E1-signal applies);

Data set E2: the vehicle's speed exceeds 90 km/h (E2-signal applies);

Data set E3: the vehicle's speed exceeds 80 km/h (E3-signal applies).

3-2.6.16.7.4.4 The class W-mode(s) of the passing beam shall not operate unless the front fog lamps, if any, are switched OFF and one or more of the following conditions is/are automatically detected (W-signal applies):

The official directions are written in Chinese, this English edition is for your reference only.

- (a) the wetness of the road has been detected automatically;
  - (b) the windshield wiper is switched ON and its continuous or automatically controlled operation has occurred for a period of at least two minutes.
- 3-2.6.16.7.4.5 A mode of a class C, V, E, or W passing beam shall not be modified to become a bending mode of said class (T-signal applies in combination with the signal of said passing beam class according to paragraphs 6.22.7.4.1. through 6.22.7.4.4. above) unless at least one of the following characteristics (or equivalent indications) are evaluated:
- (a) the angle of lock of the steering;
  - (b) the trajectory of the centre of gravity of the vehicle.
- In addition the following provisions apply:
- (i) a horizontal movement of the asymmetric cut-off side-wards from the longitudinal axis of the vehicle, if any, is allowed only when the vehicle is in forward motion 9/ and shall be such that the longitudinal vertical plane through the kink of the elbow of the cut-off does not intersect the line of the trajectory of the centre of gravity of the vehicle at distances from the front of the vehicle which are larger than 100 times the mounting height of the respective lighting unit;
  - (ii) one or more lighting units may be additionally energized only when the horizontal radius of curvature of the trajectory of the centre of gravity of the vehicle is 500 m or less.
- 3-2.6.16.7.5 It shall always be possible for the driver to set the AFS to the neutral state and to return it to its automatic operation.
- 3-2.6.16.8 Tell-tale:
- 3-2.6.16.8.1 The provisions of paragraphs 3-2.4.1.8 (for the main-beam headlamp) and 3-2.4.2.8 (for the dipped-beam headlamp) of this Regulation apply to the respective parts of an AFS.
- 3-2.6.16.8.2 A visual failure tell-tale for AFS is mandatory. It shall be non-flashing. It shall be activated whenever a failure is detected with respect to the AFS control signals or when a failure signal is received in accordance with paragraph 3-2.4.5 of Regulation. It shall remain activated while the failure is present. It may be cancelled temporarily, but shall be repeated whenever the device which starts and stops the engine is switched on and off.
- 3-2.6.16.8.3 A tell-tale to indicate that the driver has set the system into a state is optional.
- 3-2.6.16.9 Other requirements
- 3-2.6.16.9.1 If the lighting intensity for each side is over 2000 lumen and be of class C (basic) passing beam , then the lighting element of AFS shall be permitted only in conjunction with the installation of headlamp cleaning device(s).
- 3-2.6.16.9.2 Verification of compliance with AFS automatic operating requirements
- 3-2.6.16.9.2.1 The applicant shall demonstrate with a concise description or other means acceptable to the Authority responsible for type approval:
- (a) the correspondence of the AFS control signals
    - to the description required in paragraph 3.2.6. of this Regulation and
    - to the respective AFS control signals specified in the AFS type approval documents, and,
  - (b) compliance with the automatic operating requirements according to paragraphs 3-2.6.16.7.4.1 to 3-2.6.16.7.4.5 above.

- 3-2.6.16.9.2.2 To verify particular aspects of the compliance with the requirements according to paragraph 3-2.6.16.7.4 above the technical service may conduct tests and / or request the applicant to submit test reports of their in-house testing.
- 3-2.6.16.9.3 The aggregate maximum intensity of the lighting units that can be energized simultaneously to provide the main-beam lighting or its modes, if any, shall not exceed 225000 cd.
- 3-2.6.17 EMERGENCY STOP SIGNAL
- 3-2.6.17.1 The emergency stop signal shall be given by the simultaneous operation of all the stop or direction indicator lamps fitted as described in paragraph 3-2.6.17.7.
- 3-2.6.17.2 Number and color  
The same as requirements of "STOP LAMP" or "DIRECTION-INDICATOR LAMP".
- 3-2.6.17.3 Arrangement  
The same as requirements of "STOP LAMP" or "DIRECTION-INDICATOR LAMP".
- 3-2.6.17.4 Position  
The same as requirements of "STOP LAMP" or "DIRECTION-INDICATOR LAMP".
- 3-2.6.17.5 Geometric visibility  
The same as requirements of "STOP LAMP" or "DIRECTION-INDICATOR LAMP".
- 3-2.6.17.6 Orientation  
The same as requirements of "STOP LAMP" or "DIRECTION-INDICATOR LAMP".
- 3-2.6.17.7 Electrical connections
- 3-2.6.17.7.1 All the lamps of the emergency stop signal shall flash in phase at a frequency of 4.0 +/- 1.0 Hz.
- 3-2.6.17.7.1.1 However, if any of the lamps of the emergency stop signal to the rear of the vehicle use filament light sources the frequency shall be 4.0 +0.0/-1.0 Hz.
- 3-2.6.17.7.2 The emergency stop signal shall operate independently of other lamps.
- 3-2.6.17.7.3 The emergency stop signal shall be activated and deactivated automatically.
- 3-2.6.17.7.3.1 The emergency stop signal shall be activated only when the vehicle speed is above 50 km/h and the braking system is providing the emergency braking logic signal defined in "Dynamic Braking".
- 3-2.6.17.7.3.2 The emergency stop signal shall be automatically deactivated if the emergency braking logic signal is no longer provided "Dynamic Braking" or if the hazard warning signal is activated.
- 3-2.6.17.8 Tell-tale: Optional
- 3-2.6.17.9 Other requirements
- 3-2.6.17.9.1 Except as provided in paragraph 3-2.6.17.9.2 below, if a motor vehicle is designed to tow a trailer, the control of emergency stop signal on the motor vehicle shall also be capable of operating the emergency stop signal on the trailer. When the motor vehicle is electrically connected to a trailer, the flickering frequency of the emergency stop signal for the combination vehicle shall be limited to the frequency specified in paragraph 3-2.6.17.7.1.1 However, if the motor vehicle can detect that filament light sources are not being used on the trailer for the emergency stop signal, the frequency may be that specified in paragraph 3-2.6.17.7.1
- 3-2.6.17.9.2 If a motor vehicle is designed to tow a trailer fitted with a service braking system of either continuous or semi-continuous type, it shall be ensured that a constant power supply is provided via the electrical connector for the stop lamps

The official directions are written in Chinese, this English edition is for your reference only.



to such trailers while the service brake is applied.

The emergency stop signal on any such trailer may operate independently of the towing vehicle and is not required to operate either at the same frequency as, or in phase with that on the towing vehicle.

3-2.6.18 Retro-reflectors: on the side of vehicle the retro-reflectors' color shall be white or yellow and on the rear of vehicle that shall be red or yellow. The retro-reflectors used on vehicles have to comply with 「Retro-reflective material」 Regulation.

3-2.6.18.1 Applicable vehicles :

3-2.6.18.1.1 Prohibited: on vehicles of categories M1 and O1.

3-2.6.18.1.2 For the vehicles which may be fitted with Retro-reflector :

3-2.6.18.1.2.1 to the rear:

full contour marking shall be used on vehicles exceeding 2,100 mm in width of the following categories:

(a) N2 with a maximum mass exceeding 7.5 tons and all N3 (with the exception of chassis-cabs, incomplete vehicles and tractors for semi-trailers)

(b) O3 and O4

3-2.6.18.1.2.2 to the vehicle side:

3-2.6.18.1.2.2.1 partial contour marking shall be used on vehicles exceeding 6,000 mm in length (including the drawbar for trailers) of the following categories:

(a) N2 with a maximum mass exceeding 7.5 tonnes and all N3 (with the exception of chassis-cabs, incomplete vehicles and tractors for semi-trailers)

(b) O3 and O4

3-2.6.18.1.2.3 However, where the shape, structure, design or operational requirements make it impossible to install the mandatory contour marking, a line marking may be installed.

3-2.6.18.1.3 Others

3-2.6.18.1.3.1 on all other categories of vehicles, not otherwise specified in paragraphs 3-2.6.18.1.1 and 3-2.6.18.1.2 above, including the cab of tractor units for semi-trailers and the cab of chassis cabs.

3-2.6.18.1.3.2 partial or full contour marking may be applied instead of line markings, and full contour marking may be applied instead of partial contour marking.

3-2.6.18.2 Number: according to the 3-2.6.18.1.

3-2.6.18.3 Arrangement

The conspicuity markings shall be as close as practicable to horizontal and vertical, compatible with the shape, structure, design and operational requirements of the vehicle.

3-2.6.18.4 Position

3-2.6.18.4.1 Width

3-2.6.18.4.1.1 The conspicuity marking shall be as close as practicable to the edge of the vehicle.

3-2.6.18.4.1.2 The cumulative horizontal length of the conspicuity marking elements, as mounted on the vehicle, shall equate to at least 80 % of the overall width of the vehicle, excluding any horizontal overlap of individual elements.

3-2.6.18.4.1.3 However, if the manufacture can prove to the satisfaction of the authority responsible for type approval that it is impossible to achieve the value referred to in paragraph 3-2.6.18.4.1.2 above, the cumulative length may be

reduced to 60 per cent and shall be indicated in the communication document and test report .

#### 3-2.6.18.4.2 Length

3-2.6.18.4.2.1 The conspicuity marking shall be as close as practicable to the ends of the vehicle and reach to within 600 mm of each end of the vehicle (or cab in the case of tractor units for semi-trailers).

3-2.6.18.4.2.1.1 for motor vehicles, each end of the vehicle, or in the case of tractors for semi-trailers the each end of the cab;

3-2.6.18.4.2.1.2 for trailers, each end of the vehicle (excluding the drawbar).

3-2.6.18.4.2.2 The cumulative horizontal length of the conspicuity marking elements, as mounted on the vehicle, excluding any horizontal overlap of individual elements, shall equate to at least 80 % of: :

3-2.6.18.4.2.2.1 for motor vehicles, the length of the vehicle excluding the cab, or in the case of tractors for semi-trailers, if fitted, the length of the cab;

3-2.6.18.4.2.2.2 for trailers, the length of the vehicle (excluding the drawbar).

3-2.6.18.4.2.3 However, if the manufacture can prove to the satisfaction of the authority responsible for type approval that it is impossible to achieve the value referred to in paragraph 3-2.6.18.4.2.2 above, the cumulative length may be reduced to 60 per cent and shall be indicated in the communication document and test report 10/.

#### 3-2.6.18.4.3 Height

3-2.6.18.4.3.1 Line markings and contour markings lower element(s):

As low as practicable within the range:

Minimum: not less than 250 mm above the ground.

Maximum: not more than 1,500 mm above the ground.

However, a maximum mounting height of 2,100 mm may be accepted where technical conditions prevent compliance with the maximum value of 1,500 mm or, if necessary, to fulfil the requirements of paragraphs 3-2.6.18.4.1.2, 3-2.6.18.4.1.3, 3-2.6.18.4.2.2 and 3-2.6.18.4.2.3, or the horizontal positioning of the line marking or the lower element(s) of the contour marking.

3-2.6.18.4.3.2 Contour markings upper element(s):

As high as practicable, but within 400 mm of the upper extremity of the vehicle.

#### 3-2.6.18.5 Visibility

The conspicuity marking shall be considered visible, if at least 80 per cent of the illuminating surface of the marking is visible when viewed by an observer positioned at any point within the observation planes defined below:

3-2.6.18.5.1 for rear conspicuity markings the observation plane is perpendicular to the longitudinal axis of the vehicle situated 25 m from the extreme end of the vehicle and bounded by:

3-2.6.18.5.1.1 in height, by two horizontal planes 1 m and 3.0 m respectively above the ground,

3-2.6.18.5.1.2 in width, by two vertical planes which form an angle of 15 degrees outwards from the vehicle's median longitudinal plane and which pass through the intersection of the vertical planes parallel to the vehicle's median longitudinal plane delimiting the vehicle's overall width, and the plane perpendicular to the longitudinal axis of the vehicle that delimits the end of the vehicle.

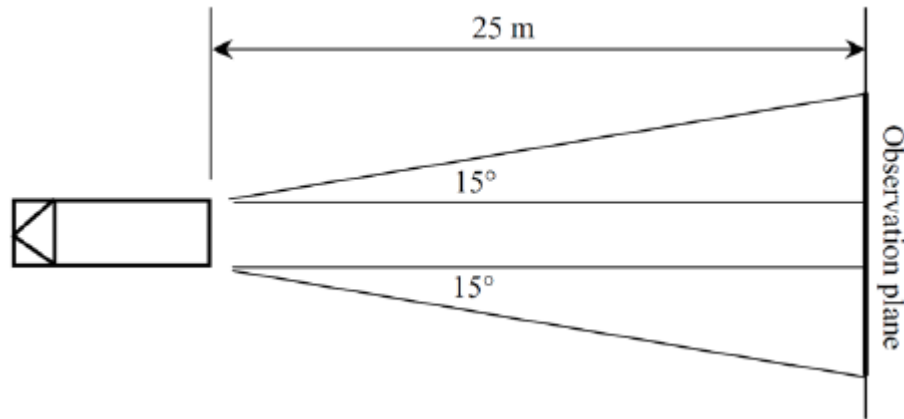

dian plane of the vehicles

3-2.6.18.5.2 for side cor

situated 25 m from. ....

3-2.6.18.5.2.1 in height, by two horizontal planes 1 m and 3.0 m respectively above the ground,

3-2.6.18.5.2.2 in width, by two vertical planes which form an angle of 15 degrees outwards from a plane perpendicular to the vehicle's longitudinal axis and which pass through the intersection of the vertical planes perpendicular to the vehicle's longitudinal axis delimiting the vehicle's overall length and the extreme outer edge of the vehicle.

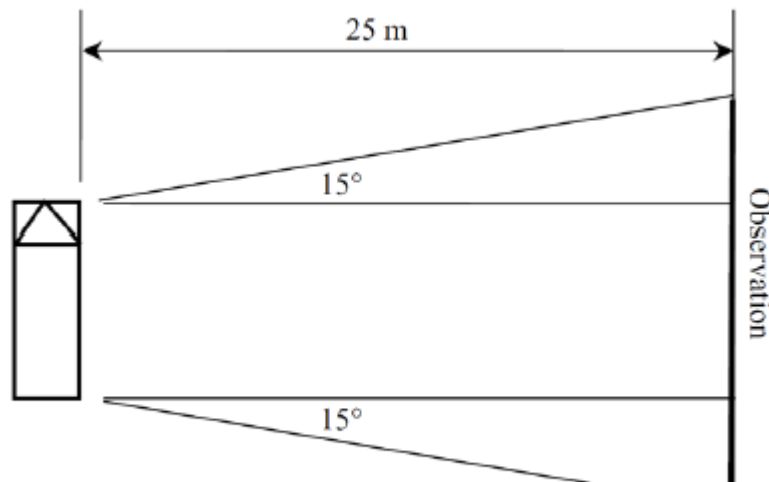

ation of lighting and light-signaling devices..

The official directions are written in Chinese, this English

## Visibility of Conspicuity Markings to the Side of a Vehicle

### 3-2.6.18.6 Orientation

#### 3-2.6.18.6.1 To the side:

Parallel to the median longitudinal plane of the vehicle, compatible with the shape, structure, design and operation requirements of the vehicle.

#### 3-2.6.18.6.2 To the rear:

Parallel to the transverse plane of the vehicle, compatible with the shape, structure, design and operation requirements of the vehicle.

### 3-2.6.18.7 Other requirements

3-2.6.18.7.1 Conspicuity markings shall be considered continuous if the distance between adjacent elements are as small as possible and do not exceed 50 percent of the shortest adjacent element length.

3-2.6.18.7.2 In the case of a partial contour marking, each upper corner shall be described by two lines at 90 degrees to each other and each at least 250 mm in length.

3-2.6.18.7.3 The distance between the conspicuity marking fitted to the rear of a vehicle and each mandatory stop lamp should be greater than 200 mm.

3-2.6.18.7.4 Where rear marking plates conforming to the 01 series of amendments to Regulation No. 70 are installed these may be considered, at the discretion of the manufacturer, as part of the conspicuity marking to the rear, for the purposes of calculating the length of the conspicuity marking and its proximity to the side of the vehicle.

3-2.6.18.7.5 The locations on the vehicle designated for reflective markings shall allow for the installation of markings of at least 60 mm in width.

### 3-2.6.19 Reversing lamp: Optional on vehicles of category symbols L2 and L5.

#### 3-2.6.19.1 Number: one or two.

#### 3-2.6.19.2 Arrangement drawing: no individual specifications.

#### 3-2.6.19.3 The colour of the light emitted by the lamps: white.

#### 3-2.6.19.4 Position

##### 3-2.6.19.4.1 At the rear of the vehicle.

##### 3-2.6.19.4.2 Height: minimum 250 mm, maximum 1,200 mm above the grounds.

#### 3-2.6.19.5 Geometric visibility

alpha = 15 degrees upwards and 5 degrees downwards;

beta = 45 degrees to the right and to the left if there is only one lamp;

beta = 45 degrees outwards and 30 degrees inwards if there a two lamps.

#### 3-2.6.19.6 Alignment: towards the rear.

The official directions are written in Chinese, this English edition is for your reference only.

### 3-2.6.19.7 Electrical connections

The lamp may not be alight unless the reverse gear is engaged and the device for switching off the engine is in a position such that it is possible for the engine to operate. It must not be possible for the lamp to be alight or remain lit if one of these conditions is unverified.

### 3-2.6.19.8 Circuit-closed telltale: optional.

### 3-2.6.20 Manoeuvring lamps

3-2.6.20.1 The Manoeuvring lamp shall conform to requirements concerning “Manoeuvring lamps” regulated in VSTD.

3-2.6.20.2 The colour of the light emitted by the lamps: white.

3-2.6.20.3 Number: One or two (one per side)

3-2.6.20.4 Arrangement : The requirements of paragraph 3-2.6.20.7 apply.

3-2.6.20.5 Orientation: Downwards, however the requirements of paragraph 3-2.6.20.7. apply.

3-2.6.20.6 Electrical Connections : Manoeuvring lamps shall be so connected that they cannot be activated unless the mainbeam headlamps or the dipped-beam headlamps are switched ON at the same time.

The manoeuvring lamp(s) shall be activated automatically for slow manoeuvres up to 10 km/h provided that one of the following conditions is fulfilled :

- (a) Prior to the vehicle being set in motion for the first time after each manual activation of the propulsion system; or
- (b) Reverse gear is engaged; or
- (c) A camera based system which assists parking manoeuvres is activated.

The manoeuvring lamps shall be automatically switched off if the forward speed of the vehicle exceeds 10 km/h and they shall remain switched off until the conditions for activation are met again.

### 3-2.6.20.7 Other requirements

3-2.6.20.7.1 The Technical Service shall, to the satisfaction of the authority responsible for type approval, perform a visual test to verify that there is no direct visibility of the apparent surface of these lamps, if viewed by an observer moving on the boundary of a zone on a transverse plane 10 m from the front of the vehicle, a transverse plane 10 m from the rear of the vehicle , and two longitudinal planes 10 m from each side of the vehicle; these four planes to extend from 1 m to 3 m above and parallel to the ground as shown in figure 7.

3-2.6.20.7.2 At the request of the applicant and with the consent of the Technical Service the requirement of 3-2.6.20.7.1 may be verified by a drawing or simulation or deemed be satisfied if the manoeuvring lamp installation conditions comply with paragraph 69.4.2 of “Manoeuvring lamps”.

3-2.7 The lamps not included in the above three chapters (3-2.4, 3-2.5 and 3-2.6) should acquire the approval of in-charge authority before installing them into the motor vehicles, trailers or motorcycles.

3-2.8 No red light which could give rise to confusion shall be emitted from a lamp in a forward direction and no white light which could give rise to confusion, other than from the reversing lamp, shall be emitted from a lamp in a rearward direction. No account shall be taken of lighting devices fitted for the interior lighting of the vehicle. In case of doubt, this requirement shall be verified as follows:

3-2.8.1 For the visibility of red light towards the front of a vehicle, with the exception of a red rearmost side-marker lamp, there must be no direct visibility of the apparent surface of a red lamp if viewed by an observer moving within Zone 1 (see Figure 5-1);

3-2.8.2 For the visibility of white light towards the rear of the vehicle, with the exception of white conspicuity markings fitted to the vehicle,

The official directions are written in Chinese, this English edition is for your reference only.

there must be no direct visibility of the apparent surface of a white lamp if viewed by an observer moving within Zone 2 in a transverse plane situated 25 m behind the vehicle (see Figure 5-2);

3-2.8.3 In their respective planes, the zones 1 and 2 explored by the eye of the observer are bounded:

3-2.8.3.1 in height, by two horizontal planes 1 m and 2.2 m respectively above the ground;

3-2.8.3.2 in width, by two vertical planes which, forming to the front and to the rear respectively an angle of 15 degrees outwards from the vehicle's median longitudinal plane, pass through the point or points of contact of vertical planes parallel to the vehicle's median longitudinal plane delimiting the vehicle's overall width; if there are several points of contact, the foremost shall correspond to the forward plane and the rearmost to the rearward plane.

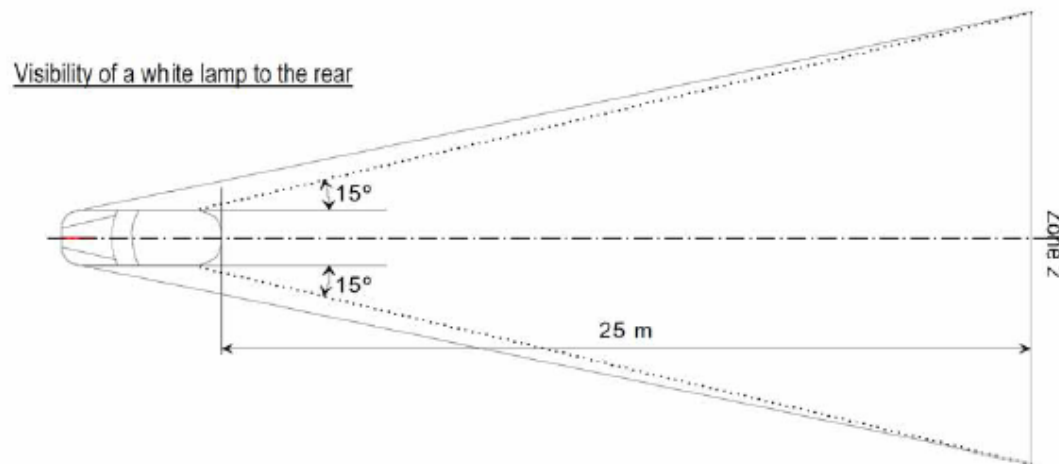
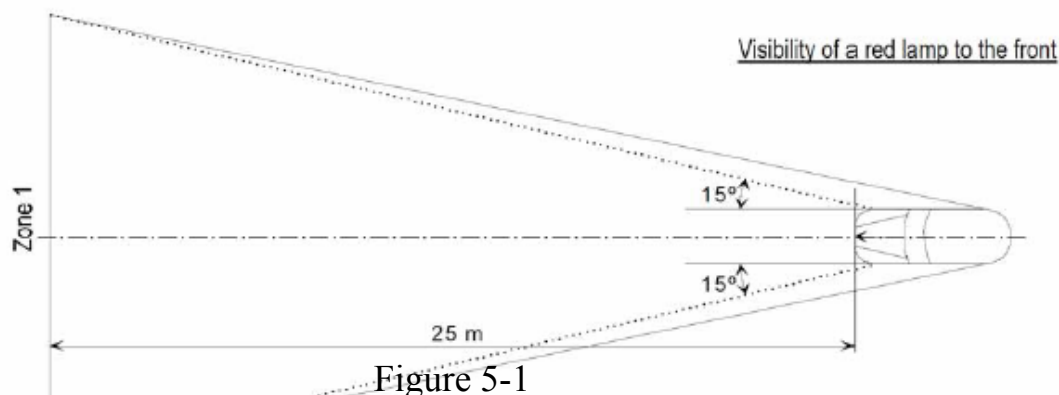





Standard symbol for  
dipped-beam headlamp

Value of the stated  
initial adjustment

The size of the symbol and characters is left to the discretion of the manufacturer



Standard symbol for  
front fog lamp

Value of the downward  
inclination

The size of the symbol and characters is left to the discretion of the manufacturer.

Zones of observation

This drawing shows the zone from one side, the other zones are from the front, the rear and from the other side of the vehicle

The official directions are written in Chinese, this English edition is for your reference only.

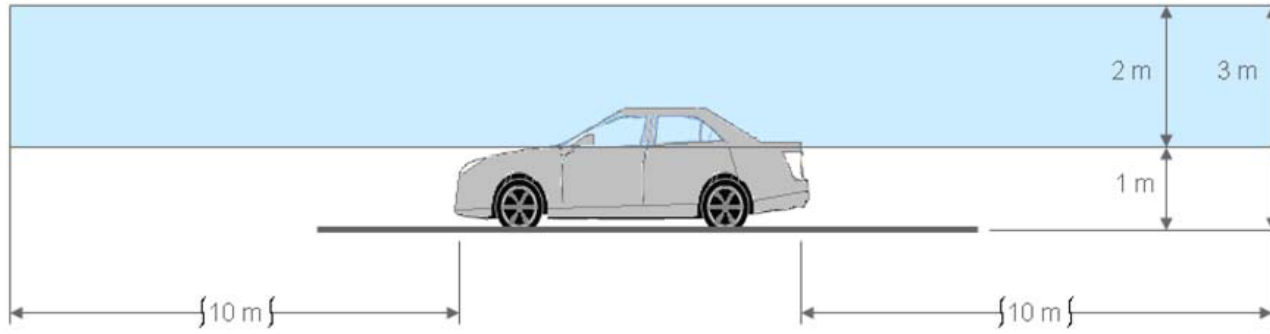

Boundaries of the zones

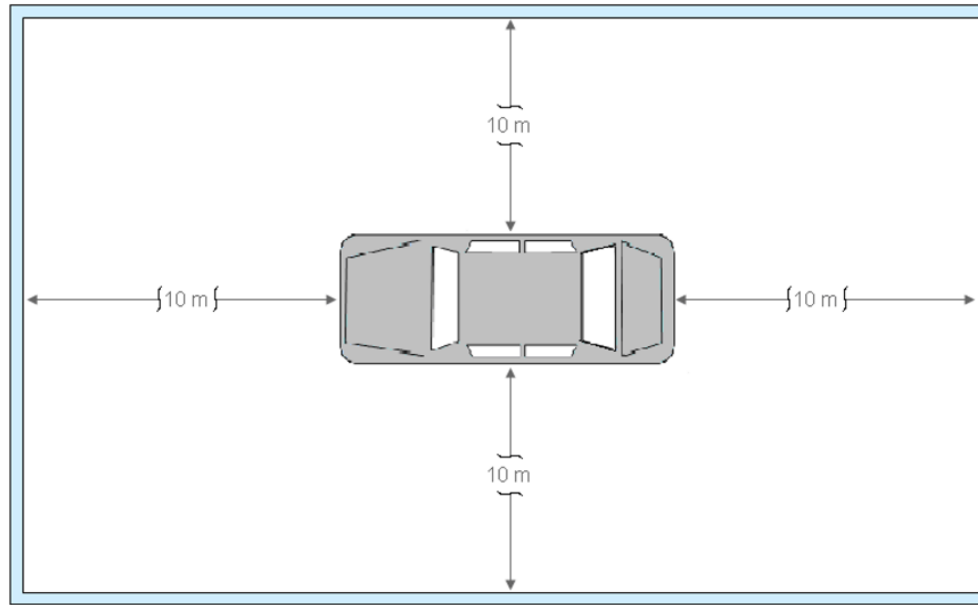

Figure 7 Zones of observation for apparent surface of manoeuvring lamps

The official directions are written in Chinese, this English edition is for your reference only.